









# GAZEL® Metal Gasket Face Seal Fittings

DNI-R p. 14	DNI/JSS p. 14	FN p. 15	MN p. 15	SMN p. 15
				
EBF p. 16	EBM p. 16	EBL p. 16	MG.EMC p. 17	MG.EM p. 17
				
EMCS-AB	EMS-AB p. 18	EMC-AB p. 19	EM-AB p. 19	EMR-AB p. 20
				
EFC p. 20	RSW p. 20	EF p. 21	EM p. 21	TA p. 21
				
MG.EFC p. 22	MG.EF p. 22	EFR-AB p. 22	EFC-AB p. 23	EF-AB p. 23
				
UM p. 24	DMRU p. 24	STMC p. 24	RA p. 25	RB p. 25
				
U-FM p. 25	CG p. 26	DFRU p. 26	U-F p. 26	UM-NPT p. 27
				
UF-NPT p. 27	UM-NPTF p. 28	UF-NPTF p. 28	UM-DB p. 29	UF-DB p. 29
				
BUP p. 30	TC p. 30	BU p. 30	BU-ABW p. 31	BU-NPT p. 31
				
BU-DB p. 31	E-NPT p. 32	E p. 32	T p. 33	C p. 33
				













# GAZEL® Space Saver Fittings

ED-2M p. 34	ED-FM p. 34	ED-2F p. 34	EX M- p. 35	MG.EX M.- p. 35
EX F- p. 35	MG.EX F- p. 35	TD-3M p. 36	TD-F2M p. 36	TD-MFM p. 36
TD-FMF p. 37	TD-M.2F p. 37	TD-3F p. 37	TX-.M.- p. 38	MG.TX-.M.- p. 38
TX-.F- p. 38	MG.TX-.F- p. 38	TX2-.M p. 39	MG.TX2-.M p. 39	TX2-.F p. 39
MG.TX2-.F p. 39	TX-. 2M p. 40	MG.TX-. 2M p. 40	TX-.FM p. 40	MG.TX-.FM p. 40
TX-.MF p. 41	MG.TX-.MF p. 41	TX-.2F p. 41	MG.TX-.2F p. 41	TX M.-.M p. 42
MG-TX M.-.Mp. 42	TX F-.M p. 42	MG.TX F-.M p. 43	TX-F-.F p. 43	MG.TX F-.F p. 43
CD-4M p. 44	CD-F3M p. 44	CD-2M.2F p. 44	CD-FMFM p. 45	CD-4F p. 45
CX M.-.M.- p. 46	MG.CX M.-.M.-p. 46	CX F-.M.- p. 46	MG.CX F-.M.-p. 47	CX F-.F- p. 47
MG.CX F-.F- p. 47				















# GAZEL® High Flow Fittings

FN-HF p. 48	MN-HF p. 48	EM-HF p. 48	UM-ABW HF p. 49	UM-AB HF p. 49
				
BU-HF p. 49	E-HF p. 50	T-HF p. 50		
				

# GAZEL® Micro Fittings

MG.RU- p. 51	MG.E- p. 51	MG.FE- p. 51	MG.EL - p. 52	MG.E5- p.
				
MG.RE- p. 53	-/MG.E- p. 53	MG.T- p. 54	MG.FT - p. 54	MG.TL - p. 55
				
MG.TUL p. 55	MG.RT- p. 56	MG.C- p. 56		
				

# GAZEL® Weld Fittings

US-AB p. 57	RU-ABW p. 57	RU-AB p. 57	E-ABW p. 58	RE-ABW p. 58
				
E-AB p. 59	RE-AB p. 59	T-ABW p. 60	RT-ABW p. 60	RTCA-W p. 61
				
MTCA-AB p. 61	T-AB p. 62	RT-AB p. 62	C-ABW p. 63	C-AB p. 63
				

Product range / *Gamme de produits* / Lieferprogramm.....3-5

Information / *Information* / Informationen.....7

Metal Gasket Face seal Fittings description  
*Principe de fonctionnement des raccords Face Seal*  
 Funktionsprinzip der Face-Seal Fittings.....8

assembly instructions  
*Instruction de montage des raccords*  
 Montageanleitung.....9

Micro Fittings and Weld Fittings description  
*Principe de fonctionnement des Micro fittings et Weld Fittings*  
 Funktionsprinzip der Micro- und Schweißfittings.....10

Technical data / *Informations techniques* / Technische Daten.....11-12

How to order / *Comment passer commande* / Bestellhinweise .....13

**PRODUCTS / PRODUITS / PRODUKTE**

- Metal Gasket Face Seal Fittings.....14-33
- Space savers Fittings.....34-47
- High flow Fittings.....48-50
- Micro fittings.....51-56
- Weld Fittings.....57-63

**GAZEL® INFORMATION**

**GAZEL® Fittings have been introduced over the world to meet five main requirements:**

- Provide quick assembly and dismantling of components and tubing.
- Guarantee perfect leak free service under vacuum and pressure.
- Achieve high quality butt welding between tube and fittings.
- Reduce dead volumes and measurements.
- Answer to highest advanced specifications.

**Our range is split up into five large families of fittings:**

1. Metal gasket Face Seal fittings
2. Space savers fittings (combination of detachable and orbital weld ends)
3. High-flow fittings
4. Micro fittings
5. Weld fittings

**INFORMATIONS GAZEL®**

**Les raccords GAZEL® ont été développés sur le marché international afin de répondre à cinq spécificités principales:**

- Permettre un montage et démontage rapide des composants et de la tuyauterie.
- Garantir une excellente étanchéité sous vide et sous pression.
- Réaliser un soudage bout à bout de haute qualité entre le tube et les raccords.
- Réduire les volumes morts et les encombrements.
- Répondre aux caractéristiques les plus rigoureuses.

**Notre gamme se compose de cinq grandes familles de raccords:**

1. Raccords à joint métallique.
2. Space savers fittings (combinaison de connexions démontable (Face Seal) et à souder).
3. Raccords haut débit.
4. Mini raccords à souder.
5. Raccords à souder.

**GAZEL® INFORMATIONEN**

**GAZEL® Fittings sind weltweit bekannt, weil sie folgende fünf Hauptanforderungen erfüllen:**

- Schnelle Montage und Demontage der Komponenten.
- Garantiert höchste Dichtheit bei Druck- und Vakuum-anwendungen.
- Erreicht höchste Qualität bei der Orbitalschweißung vom Rohr mit dem Fitting.
- Reduziert Totvolumina und Anzahl von Messungen.
- Genügt höchsten Ansprüchen und Spezifikationen.

**Das Lieferprogramm ist unterteilt in fünf große Gruppen:**

1. Metallisch dichtende Face-Seal (FS) Fittings.
2. Space Saver Fittings (Kombination von FS Fittings mit Orbital Schweiß-Enden).
3. High-Flow Fittings.
4. Micro Fittings.
5. Schweiß-Fittings.



## GAZEL® Metal Gasket Face Seal Fitting

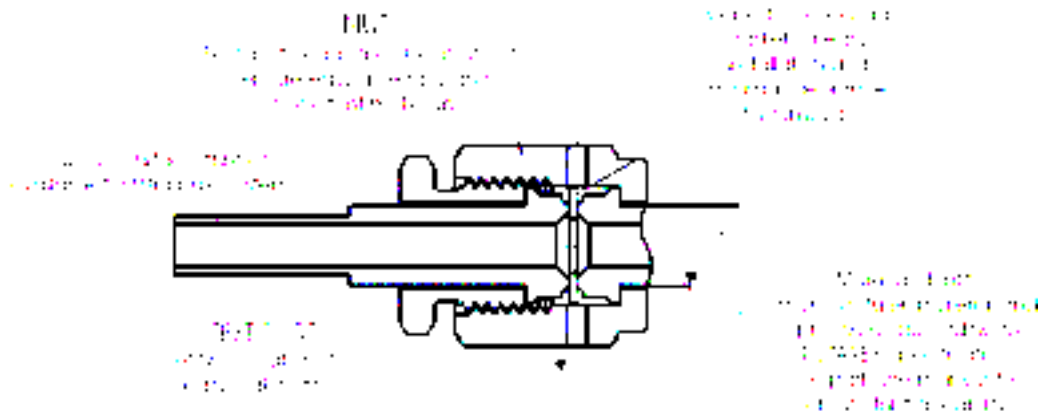

**GAZEL®** components offer the high purity of a metal to metal seal, providing leak-free service from critical vacuum to high pressure.

The seal on a **GAZEL®** assembly is made when the gasket is compressed by two highly polished beads during the engagement of a male nut or body hex and a female nut.

Les composants **GAZEL®** offrent une étanchéité métal - métal garantissant ainsi une étanchéité optimale pour des applications du vide à la haute pression.

L'étanchéité d'un ensemble **GAZEL®** est obtenue par compression du joint entre deux toroïdes pendant le serrage d'un écrou mâle ou d'un corps avec un écrou femelle.

**GAZEL®** Komponenten bieten die hohe Reinheit der Metallabdichtung und den leckfreien Betrieb bei Vakuum- bis Hochdruckanwendungen. Die Dichtung der **GAZEL®**

Verschraubung entsteht bei der Pressung der beiden Face-Seal Wülste auf die Dichtscheibe durch das Anziehen der beiden Spannelemente Überwurfmutter gegen Druckschraube.

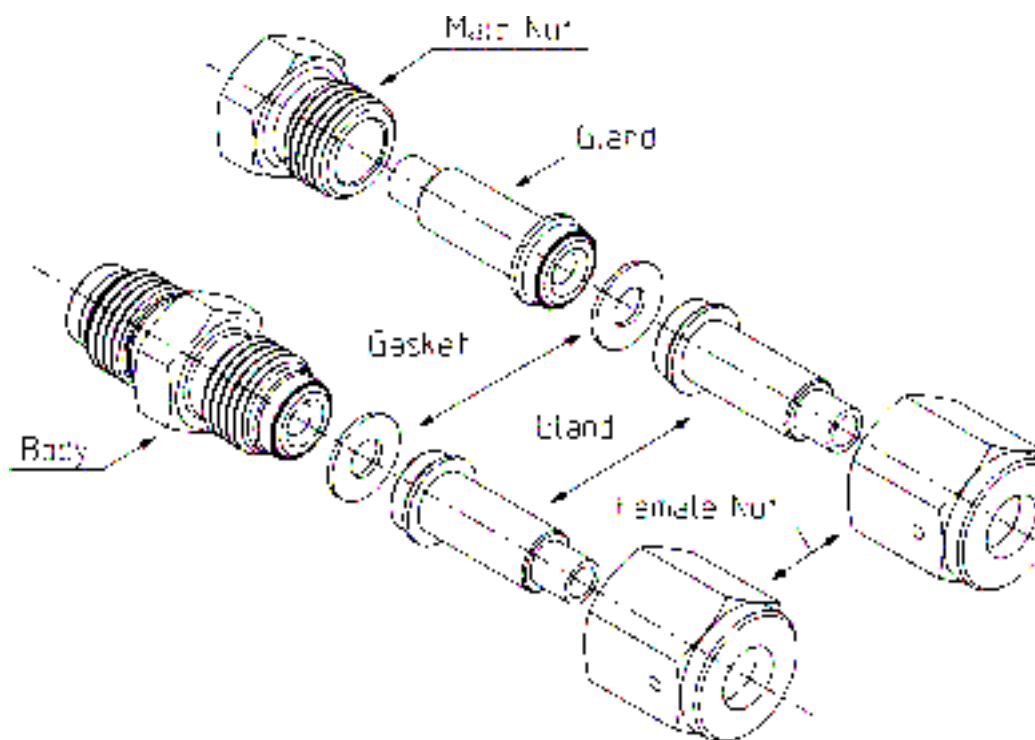

## ASSEMBLY

## MONTAGE

## MONTAGE

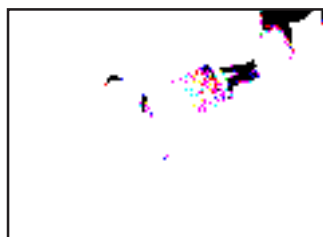

-1-

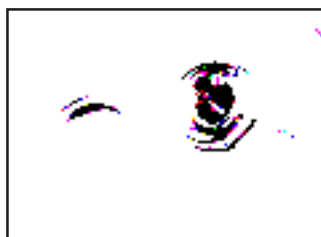

-2-

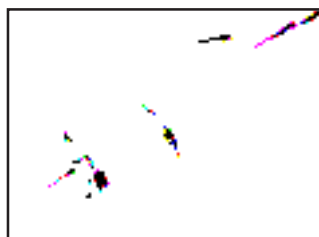

-3-



-4-

When using an original style Gasket, place it into the female nut whenever possible. No special positioning is needed, because the gasket is self-aligning. (see picture 1)

When using a gasket retainer assembly, press the assembly onto the gland as shown. The retainer assembly will locate the gasket over the bead and hold it in place. Be careful not to scratch or nick the bead as this may affect fitting performance. (see picture 2)

To assemble the connection, hold the male nut or body hex stationary. Tighten the female nut finger-tight. (see picture 3)

Hold the male nut or body hex stationary with a backup wrench. Tighten the female nut 1/8 turn past finger-tight for 316L stainless steel and nickel gaskets. (see picture 4)

### Caution:

**Excessive over-tightening will damage the sealing beads and possibly cause system leakage.**

**The using of a new gasket is necessary for each assembly (the gasket is of single use).**

En utilisant un modèle de joint standard, placez-le dans l'écrou femelle. Aucun positionnement spécial n'est nécessaire, parce que le joint est auto-centré. (cf. photo 1)

En utilisant un modèle de joint avec clip, positionnez l'ensemble sur l'embout comme indiqué. Le clip positionnera le joint sur le toroïde et le tiendra en place. Assurez-vous de ne pas rayer ou ne pas entailler le toroïde car ceci peut affecter les performances du raccord. (cf. photo 2)

Pour assembler le raccordement, tenez l'écrou mâle ou le corps hexagonal, et serrez l'écrou femelle manuellement. (cf. photo 3)

Tenez l'écrou mâle ou le corps hexagonal avec une clé. Serrez l'écrou femelle de 1/8 de tour après l'avoir serré manuellement pour un joint en acier inoxydable (316L) et en nickel. (cf. photo 4)

### Attention:

**Le serrage trop important peut générer des dommages sur le toroïde, entraînant des risques de fuite.**

**L'utilisation d'un nouveau joint est nécessaire pour chaque montage (le joint est à usage unique).**

Wenn Sie eine Original-Dichtscheibe verwenden, brauchen Sie - falls bei der Montage möglich - diese nur in das Innengewinde der Mutter zu legen; sie wird dadurch automatisch zentriert. (siehe Foto 1).

Wenn Sie eine Dichtscheibe mit Halter verwenden wollen, drücken Sie diesen auf den Stutzen, wie oben gezeigt. Der Halter dient als Montagehilfe und hält die Dichtscheibe in Position. Vorsicht, die Dichtflächen der Stutzen dürfen nicht verkratzt, bzw. beschädigt werden. (siehe Foto 2).

Um die Verschraubung zu montieren, halten Sie die Außengewindeseite fest und schrauben die Überwurfmutter "fingerfest" an. (siehe Foto 3).

Danach ziehen Sie mit den entsprechenden Gabelschlüsseln 1/8 Umdrehung bei SS- und Nickel-Dichtscheiben an. Halten Sie dabei die Druckschraube fest und drehen Sie nur die Überwurfmutter. (siehe Foto 4).

### Achtung:

**Bei jeder Montage ist eine neue Dichtscheibe zu benutzen.**

**Zu starkes Anziehen zerstört die Dichtflächen und damit die Dichtheit des Systems.**

## GAZEL® Micro Fittings

A variety of Micro fittings is available with controlled surface finishes, electropolishing and optimal cleaning according to the ROTAREX Specification and SEMASPEC to meet U.H.P system requirements.

Une variété de mini raccords à souder est disponible avec des états de surface contrôlés, électropolis et particulièrement nettoyés selon les spécifications de ROTAREX et de SEMASPEC pour répondre à des exigences U.H.P les plus sévères.

Die Vielfalt unserer Micro Fittings ist verfügbar mit unterschiedlichen, kontrollierten Oberflächengüten, Elektropolituren und speziellen Reinigungen gemäß den ROTAREX Spezifikationen und SEMASPEC, um den U.H.P Systemanforderungen zu entsprechen.



These Micro fittings provide compact U.H.P designs for use with orbital weld equipment.

Ces mini raccords à souder permettent des conceptions compactes des systèmes U.H.P en utilisant le système de soudure orbitale.

Mit dem entsprechenden Orbital-Schweißgerät ermöglichen diese Micro Fittings eine sehr kompakte U.H.P – Bauweise

## GAZEL® Weld Fittings

We provide two types of configurations for the welding section:

Nous fournissons deux types de configuration pour la section de soudure:

Wir liefern zwei Ausführungen bei den Schweiß-Enden:

- Without shoulder
- With shoulder

- Sans collerette
- Avec collerette

- Ohne Wulst
- Mit Wulst

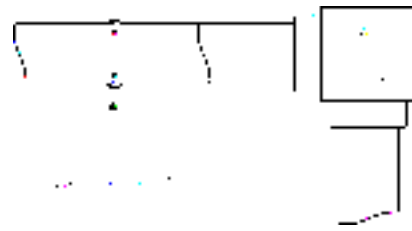
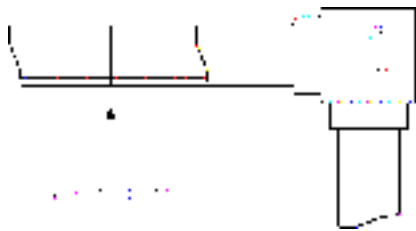

1. Without shoulder

1. Sans collerette

1. Ohne Wulst

This is the optimal configuration for butt welding using an automatic TIG welding machine.

C'est la configuration optimale pour le soudage bout à bout à l'aide d'une machine de soudure automatique TIG.

Dies ist die optimale Konfiguration für die Stoßschweißung mit einer automatischen TIG Maschine.

2. With shoulder

2. Avec collerette

2. Mit Wulst

Automatic welding configuration with shoulder to facilitate meeting under difficult welding conditions such as not easily accessible or outside piping.

La configuration de soudure automatique avec collerette permet de faciliter les assemblages dans des conditions défavorables de soudage telles que les tuyauteries peu accessibles ou d'extérieur.

Orbital-Schweiß-Konfiguration für Schweißungen unter schwierigen Bedingungen, wie zum Beispiel auf Baustellen.



**1. MATERIALS**
**1. MATERIAUX**
**1. MATERIALIEN**

Products	Material	Specification
Gasket	Nickel	ASTM B-162 (unplated)
	316L Stainless steel	ASTM A-167 (silver plated)
Nuts	316L Stainless steel	ASME SA-479, ASTM A-276
Glands, Bodies	316L Stainless steel low sulfur	Barstock: ASME SA-479, ASTM A-276
		Forgings: ASTM A-182
	VIM VAR 316L Stainless steel	Barstock: ASME SA-479, ASTM A-276 Forgings: ASTM A-182

**2. DIMENSIONS**

Dimensions are in millimeters and in inches.  
Dimensions are only for reference and are subject to change.

**2. DIMENSIONS**

Les dimensions sont en métrique (mm) et en impérial (pouces).  
Les dimensions sont données à titre indicatif et peuvent changer.

**2. ABMESSUNGEN**

Die Abmessungen sind in Millimeter und Inch angegeben.  
Die Angaben sind nur zur Information und können jederzeit geändert werden.

Size		Fractional						Metric		
		1/8"	1/4"	3/8"	1/2"	3/4"	1"	6mm	8mm	10mm
Nominal wall thickness	mm	0,71	0,89	0,89	1,25	1,25	1,65	1	1	1
	inch	0,028	0,035	0,035	0,049	0,049	0,065	0,039	0,039	0,039
Pressure ratings	PSIG	5100	5100	3300	3500	2400	2400	6800	4800	3500
	Bar	350	350	220	240	160	160	460	330	240

**3. INTERNAL SURFACE FINISH**
**3. ETAT DE SURFACE INTERNE**
**3. INNENBEREICHEN**

Grade	Surface finish		Electropolishing
	Ra $\mu$ m	Ra $\mu$ inch	
GU	0,08	3	Int. / Ext.
GP	0,15	5	Int. / Ext.
GS	0,40	16	Ext.
GI	Industrial		---

**4. FULL TRACEABILITY**

Laser etch marking identifies manufacturer, material, processes and surface levels.

**4. TRACABILITE COMPLETE**

Un marquage laser identifie le fabricant, le matériau, les processus de fabrication et l'état de surface.

**4. PRODUKT-ERKENNUNG**

Laserbeschriftungen machen präzise Angaben über Hersteller, Material, Prozess und Oberflächengüte. Auch die Material Schmelzen-Kodierung ist angegeben.

**5. PACKAGING**

Double packing in class 10 clean room.

**5. EMBALLAGE**

Double emballage en salle blanche classe 10.

**5. VERPACKUNG**

Doppelt verpackt in einem Klasse 10 Reinraum.

## TECHNICAL DATA

## INFORMATIONS TECHNIQUES

## TECHNISCHE DATEN

### 6. TESTING

Gazel fittings has been helium leak tested to a rate of  $10^{-10}$  std cm<sup>3</sup>/sec.

### 7. PRESSURE RATINGS

Pressure ratings are calculated in accordance with power piping code ANSI B 31.1 for stainless steel fittings at ambient temperature.

### 8. TEMPERATURE RATINGS

### 6. TEST

Les raccords GAZEL ont été testés à l'hélium à une valeur de  $10^{-10}$  std cm<sup>3</sup>/sec.

### 7. PRESSION

Les estimations de pression sont définies selon la norme ANSI B 31,1 pour des raccords en acier inoxydable à température ambiante.

### 8. TEMPERATURE

### 6. PRÜFUNGEN

Gazel Fittings sind Helium-Leck getestet:  $10^{-10}$  std cm<sup>3</sup>/sec.

### 7. DRUCKANGABEN

Die Druckbereiche wurden bei Raumtemperatur unter Verwendung von Rohren nach ANSI B 31.1 ausgelegt.

### 8. TEMPERATUR

Material	Temperature	
	°C	°F
Nickel	315	600
316L Stainless steel VIM VAR and low sulfur	537	1000

### 9. PRODUCT INSPECTION AND TEST

#### Product inspection

- Dimensional inspection.
- Internal and external visual inspection.
- Internal roughness measurement

The following tests are carried out at the request of customers:

- ESCA: Electron Spectroscopy for Chemical Analyses
- AES: Argon Electron Spectroscopy
- Corrosion test
- Internal fitting measurement

### 10. THREE STAR QUALITY PROCESS

- ISO 9001 Certification N°: DE-062832 Q1.
- Fully integrated processing (machining, electropolishing, decontamination, packaging, orbital welding).
- Fully traceability at all steps (SPC CAQS).
- Continuous monitoring of key process parameters.

### 9. INSPECTION ET TEST DES PRODUITS

#### Inspection du produit

- Contrôle dimensionnel
- Inspection visuelle interne et externe.
- Mesure interne de rugosité

Les essais suivant sont effectués sur demande des clients:

- ESCA: Electron Spectroscopy for Chemical Analyses
- AES: Argon Electron Spectroscopy
- Test de corrosion
- Mesures internes du raccord

### 10. THREE STAR QUALITY PROCESS

- Certification ISO 9001 N°:DE-062832 Q1.
- Procédé de fabrication complet intégré (usinage, électropolissage, décontamination, emballage, soudure orbitale).
- Traçabilité complète à toutes les étapes de fabrication (SPC CAQS).
- Contrôle et enregistrement en continu des principaux paramètres de fabrication.

### 9. PRODUKT-KONTROLLE UND PRÜFUNGEN

#### Produktkontrollen

- Sichtkontrolle.
- Visuelle Kontrolle der Innenflächen.
- Innenflächenrauhigkeits-Messungen.

Folgende Prüfungen können auf Kundenwunsch ausgeführt werden:

- ESCA: Elektronen Spektroskopie für die Chemische Analyse
- AES: Argon Elektronen Spektroskopie
- Korrosions-Test
- Innenfitting-Messungen

### 10. THREE STAR QUALITY PROCESS

- ISO 9001 Zertifizierung N°: DE-062832 Q1.
- Völlig integrierter Fertigungsablauf (mechanische Fertigung, Orbitalschweißen, Elektropolieren, Dekontaminieren, Verpacken).
- Zu jeder Fertigungsstufe nachverfolgbar (SPC CAQS).
- Ständige Überwachung der wesentlichen Prozess-Parameter.

## NOMENCLATURE

## NOMENCLATURE

## ARTIKELBESTIMMUNG

### HOW TO ORDER

- The part number on the fittings data sheets designate the type and the size.
- Just add the material and the surface finish composition symbols shown below for

example:

- For material composition add A, L, V, M, N or H.
- For surface finish add GI, GS, GP or GU.

### COMMANDER

- La référence des articles du catalogue donne le type et les dimensions.
- Ajoutez juste les symboles pour la matière et pour la finition de l'article (voir exemple ci-dessous):

exemple:

- Pour la matière, ajoutez A, L, V, M, N ou H.
- Pour l'état de surface, ajoutez GI, GS, GP or GU.

### BESTELLHINWEISE

- Die Referenz der Artikel im Katalog ergeben den Typ und die Abmaße.
- Fügen Sie nur die Symbole für den Werkstoff und Oberflächengüte des Artikels hinzu (ein Beispiel ist unten angegeben):

Beispiel:

- Für den Werkstoff, fügen Sie A, L, V, M, N oder H hinzu.
- Für die Oberflächenbeschaffenheit, fügen Sie GI, GS, GP oder GU hinzu.

PART NUMBER	MATERIAL	SURFACE FINISH
-------------	----------	----------------

Example  
Exemple:  
Beispiel

**EMC 14 AB / V / GP**



gives the type and size of the fittings

A = 316L Standard  
L = 316L Low Sulfur (av. S: 0.005%)  
V = 316L VIM VAR  
M = Low Manganese (on request)  
N = NICKEL  
H = Hastelloy® C-22 (on request)



Grade	Surface finish		Electropolishing
	Ra µm	Ra µinch	
GU	0,08	3	Int. / Ext.
GP	0,15	5	Int. / Ext.
GS	0,40	16	Ext.
GI	Industrial		---

Diameter	Fractional							Metric		
	1/16"	1/8"	1/4"	3/8"	1/2"	3/4"	1"	6mm	8mm	10mm
Size Part Number	116	18	14	38	12	34	100	6M	8M	10M

# GAZEL® Metal Gasket Face Seal Fittings

## GASKETS

## JOINTS

## DICHTSCHEIBEN

### NICKEL GASKET & RETAINER JOINT NICKEL AVEC CLIP DICHTSCHEIBEN AUS NICKEL MIT HALTERUNG

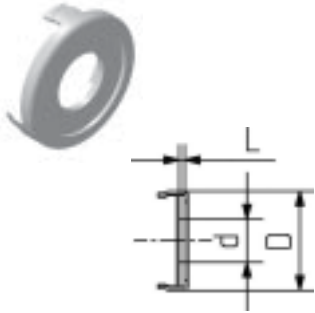

Tube O.D.	Part Number	L		d		D	
		mm	INCH	mm	INCH	mm	INCH
1/4", 6mm, 8mm	DNI 14 R	0,7	0,03	6,1	0,24	12,7	0,50
3/8", 1/2", 10mm, 12mm	DNI 12 R	0,7	0,03	11,2	0,44	20,1	0,79
3/4", 18mm	DNI 34 R	0,7	0,03	16,8	0,66	29,0	1,14
1"	DNI 100 R	0,7	0,03	22,6	0,89	35,6	1,40

### GASKET - NICKEL JOINT NICKEL DICHTSCHEIBEN - NICKEL

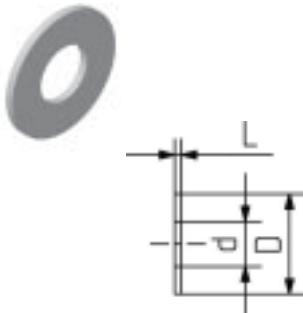

Tube O.D.	Part Number	L		d		D	
		mm	INCH	mm	INCH	mm	INCH
1/8"	DNI 18	0,5	0,02	2,3	0,09	6,6	0,26
1/4", 6mm, 8mm	DNI 14	0,7	0,03	6,1	0,24	11,9	0,47
3/8", 1/2", 10mm, 12mm	DNI 12	0,7	0,03	11,2	0,44	19,8	0,78
3/4", 18mm	DNI 34	0,7	0,03	16,8	0,66	29,0	1,14
1"	DNI 100	0,7	0,03	22,6	0,89	35,6	1,40

### GASKET - SILVER PLATED 316L JOINT INOX 316L RECOUVERT D'ARGENT DICHTSCHEIBEN AUS EDELSTAHL 316L - VERSILBERT

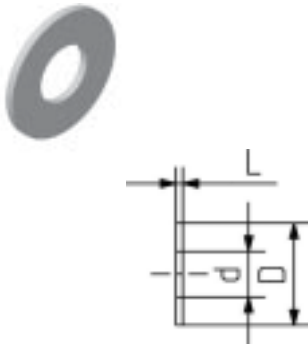

Tube O.D.	Part Number	L		d		D	
		mm	INCH	mm	INCH	mm	INCH
1/8"	JSS 18	0,5	0,02	2,3	0,09	6,6	0,26
1/4", 6mm, 8mm	JSS 14 ① ②	0,7	0,03	6,1	0,24	11,9	0,47
3/8", 1/2", 10mm, 12mm	JSS 12 ①	0,7	0,03	11,2	0,44	19,8	0,78
3/4", 18mm	JSS 34 ①	0,7	0,03	16,8	0,66	29,0	1,14
1"	JSS 100 ①	0,7	0,03	22,6	0,89	35,6	1,40

① On request: for silver plated Nickel, use the prefix JNI (Example: JNI 14) - ② On request: blind gasket, use part number JSS 14 EB

# GAZEL® Metal Gasket Face Seal Fittings

## NUTS

## ECROUS

## DRUCKSCHRAUBEN / MUTTERN

### FEMALE NUT ECROU FEMELLE MUTTER

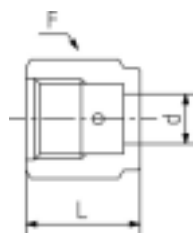

Tube O.D.	Part Number	L		d		F
		mm	INCH	mm	INCH	
1/8"	FN 18	13,5	0,53	5,3	0,21	11,1
1/4", 6mm, 8mm	FN 14	20,6	0,81	9,1	0,36	19,1
3/8", 1/2", 10mm, 12mm	FN 12	22,4	0,88	15,5	0,61	27,0
3/4", 18mm	FN 34	28,4	1,12	22,6	0,89	38,1
1"	FN 100	34,0	1,34	30,5	1,20	44,5

### MALE NUT ECROU MALE DRUCKSCHRAUBE

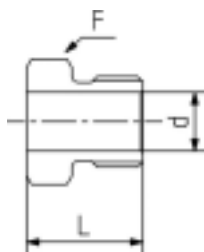

Tube O.D.	Part Number	L		d		F
		mm	INCH	mm	INCH	
1/8"	MN 18	12,7	0,50	5,3	0,21	9,5
1/4", 6mm, 8mm	MN 14 ①	18,0	0,71	9,1	0,36	15,9
3/8", 1/2", 10mm, 12mm	MN 12	20,6	0,81	15,5	0,61	23,8
3/4", 18mm	MN 34	25,4	1,00	22,6	0,89	33,3
1"	MN 100	30,2	1,19	30,5	1,20	41,3

① A taper at the hex allows the nut to move around 90° tube bends

### SHORT MALE NUT ECROU MALE COURT DRUCKSCHRAUBE KURZ

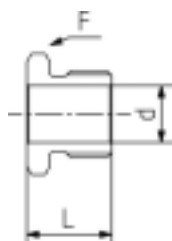

Tube O.D.	Part Number	L		d		F
		mm	INCH	mm	INCH	
1/4", 6mm, 8mm	SMN 14	13,7	0,54	9,1	0,36	15,9
1/4", 6mm, 8mm	SMN 14.6	16,5	0,65	9,1	0,36	15,9

# GAZEL® Metal Gasket Face Seal Fittings

## PLUGS

## OBTURATEURS

## VERFSCHLUSSKAPPEN

### FEMALE CAP BOUCHON FEMELLE VERSCHLUSSKAPPEN

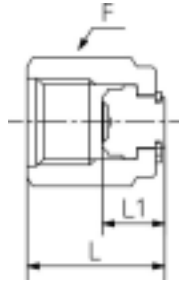

Tube O.D.	Part Number	L		L1		F
		mm	INCH	mm	INCH	mm
1/4", 6mm, 8mm	EBF 14 ①	23,9	0,94	11,2	0,44	19,1
3/8", 1/2", 10mm, 12mm	EBF 12 ①	25,6	1,01	11,4	0,45	27,0
3/4", 18mm	EBF 34	32,8	1,29	13,7	0,54	38,1
1"	EBF 100	39,1	1,54	16,0	0,63	44,5

### MALE PLUG BOUCHON MALE VERSCHLUSSTOPFEN

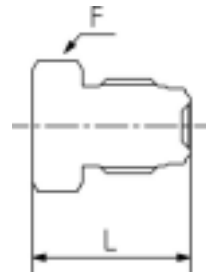

Tube O.D.	Part Number	L		F
		mm	INCH	mm
1/8"	EBM 18	17,3	0,68	9,5
1/4", 6mm, 8mm	EBM 14 ② ③	23,4	0,92	15,9
3/8", 1/2", 10mm, 12mm	EBM 12 ③	27,4	1,08	23,8
3/4", 18mm	EBM 34	36,3	1,43	33,3
1"	EBM 100	38,6	1,52	41,3

### GLAND PLUG OBTURATEUR BLINDSTUTZEN

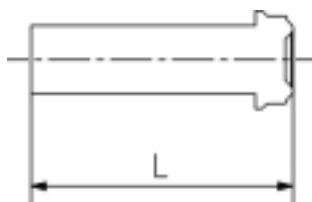

Tube O.D.	Part Number	L	
		mm	INCH
1/8"	EBL 18	17,8	0,70
1/4", 6mm, 8mm	EBL 14 ④	33,3	1,31
3/8", 1/2", 10mm, 12mm	EBL 12	38,1	1,50
3/4", 18mm	EBL 34	50,8	2,00
1"	EBL 100	56,4	2,22

- ① On request with lanyard, use EBFL as a part number (Example: EBFL 14)
- ② Also available as a rotatable plug. Ordering number: EBMR 14
- ③ On request with lanyard, use EBML as a part number (Example: EBML 14)
- ④ On request it can be delivered with L = 19.0 (0.75") Part number: EB 14

# GAZEL® Metal Gasket Face Seal Fittings

## GLANDS

## EMBOUTS

## STUTZEN

### MINI SHORT MALE GLAND EMBOUT MALE COURT MINI MINI KURZSTUTZEN

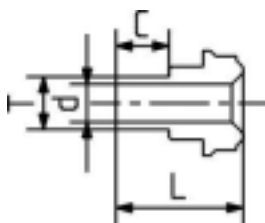

T Tube O.D.	Part Number	L		d		C		Nominal Wall Thickness		Working Pressure	
		mm	INCH	mm	INCH	mm	INCH	mm	INCH	PSIG	BAR
<b>Fractional</b>											
1/4"	MG.EMC 14 ①	15,2	0,60	4,6	0,18	6,4	0,25	0,89	0,035	5100	350
3/8"	MG.EMC 38	15,7	0,62	7,7	0,30	6,4	0,25	0,89	0,035	3300	220
1/2"	MG.EMC 12	15,7	0,62	10,2	0,40	6,4	0,25	1,25	0,049	3500	240
<b>Metric</b>											
6mm	MG.EMC 6M	15,2	0,60	4,0	0,16	6,4	0,25	1,0	0,039	6800	460
8mm	MG.EMC 8M	15,7	0,62	6,0	0,24	6,4	0,25	1,0	0,039	4800	330
<b>Jis</b>											
1/4"	MG.EMC 14J	15,2	0,60	4,4	0,17	6,4	0,25	1,0	0,039	5600	380
3/8"	MG.EMC 38J	15,7	0,62	7,5	0,29	6,4	0,25	1,0	0,039	3500	240

### MINI MALE GLAND EMBOUT MALE MINI MINI STUTZEN

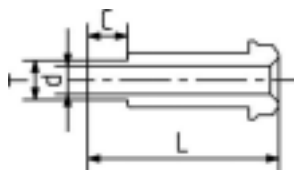

T Tube O.D.	Part Number	L		d		C		Nominal Wall Thickness		Working Pressure	
		mm	INCH	mm	INCH	mm	INCH	mm	INCH	PSIG	BAR
<b>Fractional</b>											
1/8"	MG.EM 18 ②	23,4	0,92	2,1	0,08	6,4	0,25	0,71	0,028	5100	350
1/4"	MG.EM 14	30,5	1,20	4,6	0,18	6,4	0,25	0,89	0,035	5100	350
3/8"	MG.EM 38	32,8	1,29	7,7	0,30	6,4	0,25	0,89	0,035	3300	220
1/2"	MG.EM 12	32,8	1,29	10,2	0,40	6,4	0,25	1,25	0,049	3500	240
<b>Metric</b>											
6mm	MG.EM 6M	30,5	1,20	4,0	0,16	6,4	0,25	1,0	0,039	6800	460
<b>Jis</b>											
1/4"	MG.EM 14J	30,5	1,20	4,4	0,17	6,4	0,25	1,0	0,039	5600	380
3/8"	MG.EM 38J	32,8	1,29	7,5	0,29	6,4	0,25	1,0	0,039	3500	240

① On request in Alloy C-22 (HC22) material - ② Minimum quantity

# GAZEL® Metal Gasket Face Seal Fittings

## GLANDS

## EMBOUTS

## STUTZEN

**AUTOMATIC TUBE WELD SHORT MALE GLAND**  
**EMBOUT MALE COURT POUR SOUDURE AUTOMATIQUE BOUT A BOUT**  
**VERKÜRZTER STUTZEN FÜR AUTOMATISCHE STUMPFSCHEISSUNG**

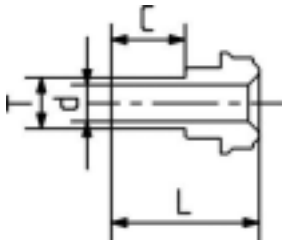

T Tube O.D.	Part Number	L		d		C		Nominal Wall Thickness		Working Pressure	
		mm	INCH	mm	INCH	mm	INCH	mm	INCH	PSIG	BAR
<b>Fractional</b>											
1/4"	EMCS 14 AB	18,3	0,72	4,6	0,18	9,6	0,38	0,89	0,035	5100	350
1/2"	EMCS 12 AB	18,8	0,74	10,2	0,40	9,6	0,38	1,25	0,049	3500	240
<b>Jis</b>											
1/4"	EMCS 14J AB	18,3	0,72	4,4	0,17	9,6	0,38	1,0	0,039	5600	380
3/8"	EMCS 38J AB	18,8	0,74	7,5	0,29	9,6	0,38	1,0	0,039	3500	240

**AUTOMATIC TUBE WELD MALE GLAND**  
**EMBOUT MALE POUR SOUDURE AUTOMATIQUE BOUT A BOUT**  
**STUTZEN FÜR AUTOMATISCHE STUMPFSCHEISSUNG**

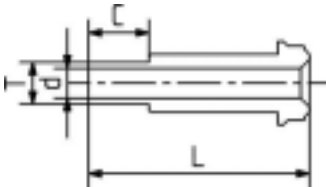

T Tube O.D.	Part Number	L		d		C		Nominal Wall Thickness		Working Pressure	
		mm	INCH	mm	INCH	mm	INCH	mm	INCH	PSIG	BAR
<b>Fractional</b>											
1/4"	EMCA 14 AB	33,3	1,31	4,6	0,18	9,1	0,36	0,89	0,035	5100	350
1/4"	EMS 14 AB	33,5	1,32	4,6	0,18	9,6	0,38	0,89	0,035	5100	350
1/2"	EMS 12 AB	35,8	1,41	10,2	0,40	9,6	0,38	1,25	0,049	3500	240
<b>Jis</b>											
1/4"	EMS 14J AB	33,5	1,32	4,4	0,17	9,6	0,38	1,0	0,039	5600	380
3/8"	EMS 38J AB	35,8	1,41	7,5	0,29	9,6	0,38	1,0	0,039	3500	240



# GAZEL® Metal Gasket Face Seal Fittings

## GLANDS

## EMBOUTS

## STUTZEN

### AUTOMATIC TUBE WELD SHORT MALE GLAND EMBOUT MALE COURT POUR SOUDURE AUTOMATIQUE BOUT A BOUT REDUZIERSTUTZEN FÜR AUTOMATISCHES SCHWEISSEN

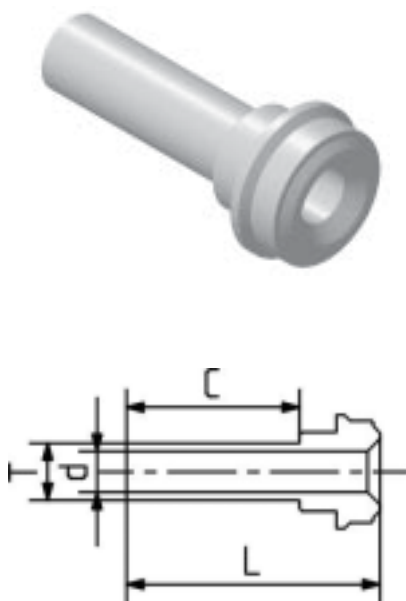

T Tube O.D.	Part Number	L		d		C		Nominal Wall Thickness		Working Pressure	
		mm	INCH	mm	INCH	mm	INCH	mm	INCH	PSIG	BAR
<b>Fractional</b>											
1/8"	EMC 18 AB ②	27,4	1,08	2,1	0,08	19,1	0,75	0,71	0,028	5100	350
1/4"	EMC 14 AB ①	27,9	1,10	4,6	0,18	19,1	0,75	0,89	0,035	5100	350
3/8"	EMC 38 AB ①	28,4	1,12	7,7	0,30	19,1	0,75	0,89	0,035	3300	220
1/2"	EMC 12 AB ①	28,4	1,12	10,2	0,40	19,1	0,75	1,25	0,049	3500	240
<b>Metric</b>											
6mm	EMC 6M AB	29,5	1,16	4,0	0,16	19,1	0,75	1,0	0,039	6800	460
8mm	EMC 8M AB	29,5	1,16	6,0	0,24	19,1	0,75	1,0	0,039	4800	330
10mm	EMC 10M AB	29,5	1,16	8,0	0,31	19,1	0,75	1,0	0,039	3500	240
12mm	EMC 12M AB	29,5	1,16	10,0	0,39	19,1	0,75	1,0	0,039	3100	210
18mm	EMC 18M AB ②	31,0	1,22	15,0	0,59	19,1	0,75	1,5	0,059	3000	200
<b>Jis</b>											
1/4"	EMC 14J AB	27,9	1,10	4,4	0,17	19,1	0,75	1,0	0,039	5600	380
3/8"	EMC 38J AB	28,4	1,12	7,5	0,29	19,1	0,75	1,0	0,039	3300	240

### AUTOMATIC TUBE WELD MALE GLAND EMBOUT MALE POUR SOUDURE AUTOMATIQUE BOUT A BOUT STUTZEN FÜR AUTOMATISCHES STUMPFSCHEISSEN

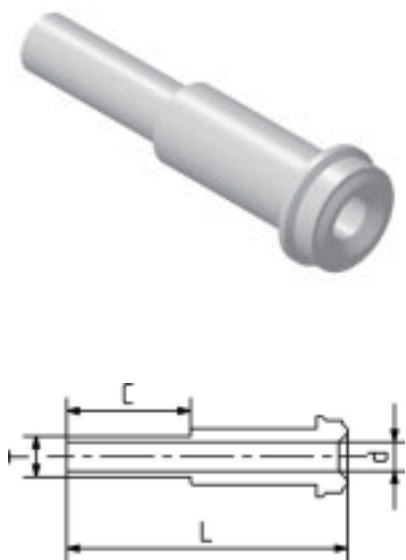

T Tube O.D.	Part Number	L		d		C		Nominal Wall Thickness		Working Pressure	
		mm	INCH	mm	INCH	mm	INCH	mm	INCH	PSIG	BAR
<b>Fractional</b>											
1/8"	EM 18 AB ②	36,1	1,42	2,1	0,08	19,1	0,75	0,71	0,028	5100	350
1/4"	EM 14 AB ①	43,2	1,70	4,6	0,18	19,1	0,75	0,89	0,035	5100	350
3/8"	EM 38 AB	45,5	1,79	7,7	0,30	19,1	0,75	0,89	0,035	3300	220
1/2"	EM 12 AB	45,5	1,79	10,2	0,40	19,1	0,75	1,25	0,049	3500	240
3/4"	EM 34 AB	51,6	2,03	16,5	0,65	19,1	0,75	1,25	0,049	2400	160
1"	EM 100 AB	58,9	2,32	22,1	0,87	19,1	0,75	1,65	0,065	2400	160
<b>Metric</b>											
6mm	EM 6M AB	43,1	1,70	4,0	0,16	19,1	0,75	1,0	0,039	6800	460
8mm	EM 8M AB	43,1	1,70	6,0	0,24	19,1	0,75	1,0	0,039	4800	330
10mm	EM 10M AB	45,5	1,79	8,0	0,31	19,1	0,75	1,0	0,039	3500	240
12mm	EM 12M AB	45,5	1,79	10,0	0,39	19,1	0,75	1,0	0,039	3100	210
18mm	EM 18M AB	51,6	2,03	15,0	0,59	19,1	0,75	1,5	0,059	3000	200
<b>Jis</b>											
1/4"	EM 14J AB	43,2	1,70	4,4	0,17	19,1	0,75	1,0	0,039	5600	380
3/8"	EM 38J AB	45,5	1,79	7,5	0,29	19,1	0,75	1,0	0,039	3300	240

① On request in Alloy C-22 (HC22) material - ② Minimum quantity

# GAZEL® Metal Gasket Face Seal Fittings

## GLANDS

## EMBOUTS

## STUTZEN

### AUTOMATIC TUBE WELD REDUCING MALE GLAND EMBOUT REDUCTION POUR SOUDURE AUTOMATIQUE BOUT A BOUT REDUZIERSTUTZEN FÜR AUTOMATISCHE STUMPFSCHEISSUNG

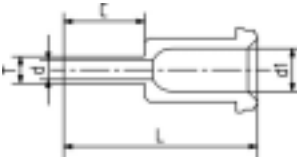

T1 Tube O.D.	T Tube O.D.	Part Number	L		d1		d		C		Nominal Wall Thickness		Working Pressure	
			mm	INCH	mm	INCH	mm	INCH	mm	INCH	mm	INCH	PSIG	BAR
<b>Fractional</b>														
1/2"	1/4"	EMR 12 14 AB	45,5	1,79	10,2	0,40	4,6	0,18	19,1	0,75	0,89	0,035	3500	240
1/2"	3/8"	EMR 12 38 AB	45,5	1,79	10,2	0,40	7,7	0,30	19,1	0,75	0,89	0,035	3300	220
1/2"	1/4"	EMCR 12 14 AB	28,4	1,12	10,2	0,40	4,6	0,18	19,1	0,75	0,89	0,035	3500	240
1/2"	3/8"	EMCR 12 38 AB ①	28,4	1,12	10,2	0,40	7,7	0,30	19,1	0,75	0,89	0,035	3300	220

### SHORT SOCKET WELD GLAND EMBOUT COURT A SOUDER PAR EMBOITEMENT VERKÜRZTER STUTZEN FÜR ANWENDUNGEN MIT HOHEM DURCHFLUSS

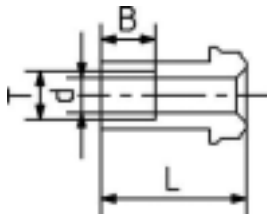

T Tube O.D.	Part Number	L		d		B	Working Pressure	
		mm	INCH	mm	INCH		PSIG	BAR
<b>Fractional</b>								
1/4"	EFCS 14	12,7	0,50	4,6	0,18	7,9	5500	370
1/4"	EFC 14	19,1	0,75	4,6	0,18	7,1	5500	370

### REDUCING SOCKET WELD GLAND EMBOUT REDUCTEUR A SOUDER PAR EMBOITEMENT REDUZIERSTUTZEN FÜR EINSTECKSCHWEISSEN

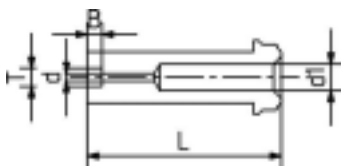

T1 Tube O.D.	T Tube O.D.	Part Number	L		d1		d		B	Working Pressure	
			mm	INCH	mm	INCH	mm	INCH		mm	PSIG
<b>Fractional</b>											
1/4"	1/8"	RSW 14 18	33,3	1,31	4,6	0,18	2,1	0,08	2,5	8000	550
1/2"	1/4"	RSW 12 14	38,0	1,50	10,2	0,40	4,6	0,18	7,1	3500	240

① On request in Alloy C-22 (HC22) material

# GAZEL® Metal Gasket Face Seal Fittings

## GLANDS

## EMBOUTS

## STUTZEN

**SOCKET WELD GLAND**  
**EMBOUT A SOUDER PAR EMBOITEMENT**  
**STUTZEN FÜR EINSTECKSCHWEISSEN**

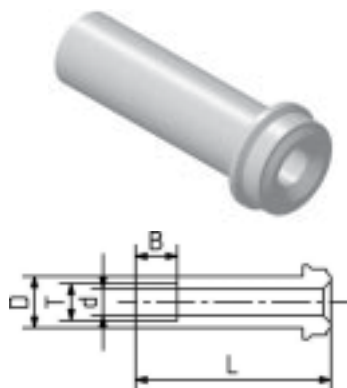

T Tube O.D.	Part Number	L		d		D	B	Working Pressure	
		mm	INCH	mm	INCH	mm	mm	PSIG	BAR
<b>Fractional</b>									
1/16"	EF 116 ① ②	17,8	0,70	1,5	0,06	3,3	2,5	9000	620
1/8"	EF 18	17,8	0,70	2,1	0,08	5,1	2,5	7100	480
1/4"	EF 14	33,3	1,31	4,6	0,18	8,9	7,1	5500	370
3/8"	EF 38	38,1	1,50	7,7	0,30	15,2	8,0	3500	240
1/2"	EF 12	38,1	1,50	10,2	0,40	15,2	9,6	3000	200
3/4"	EF 34	50,8	2,00	16,5	0,65	22,4	11,2	2800	190
1"	EF 100	56,4	2,22	22,1	0,87	30,2	15,7	2400	160

**MALE WELD GLAND**  
**EMBOUT MALE A SOUDER**  
**STUTZEN FÜR STUMPSCHWEISSUNG**

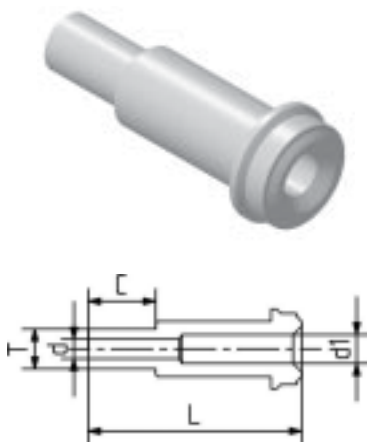

T1 Tube O.D.	T Tube O.D.	Part Number	L		d1		d		C		Working Pressure	
			mm	INCH	mm	INCH	mm	INCH	mm	INCH	PSIG	BAR
<b>Fractional</b>												
1/8"	1/8"	EM 18	17,8	0,70	1,5	0,06	2,1	0,08	7,1	0,28	9000	620
1/4"	1/8"	EMR 14 18	33,3	1,31	1,5	0,06	2,1	0,08	7,1	0,28	8000	550
1/4"	1/4"	EM 14	33,3	1,31	3,0	0,12	4,6	0,18	10,4	0,41	8000	550
1/2"	1/4"	EMR 12 14	38,1	1,50	3,0	0,12	4,6	0,18	10,4	0,41	3500	240
1/2"	3/8"	EM 38	38,1	1,50	7,1	0,28	7,7	0,30	10,4	0,41	3500	240
1/2"	1/2"	EM 12	38,1	1,50	10,2	0,40	10,2	0,40	12,7	0,50	3500	240
3/4"	3/4"	EM 34	50,8	2,00	13,5	0,53	16,5	0,65	15,7	0,62	3000	200
1"	1"	EM 100	56,4	2,22	19,1	0,75	22,1	0,87	20,6	0,81	2400	160

**TUBE ADAPTER**  
**EMBOUT ADAPTEUR TUBE**  
**STUTZEN FÜR DOPPELRINGVERSCHRAUBUNG**

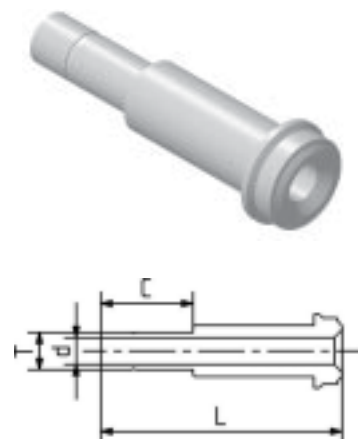

T Tube O.D.	Part Number	L		d		C		Working Pressure	
		mm	INCH	mm	INCH	mm	INCH	PSIG	BAR
<b>Fractional</b>									
1/4"	TA 14	41,0	1,61	4,6	0,18	16,2	0,64	2400	160
3/8"	TA 38	46,0	1,81	7,7	0,30	17,8	0,70	1500	100
1/2"	TA 12	49,3	1,94	10,2	0,40	24,4	0,96	1500	100

① Use DNI 18 and FN 18 or MN 18 - ② Minimum quantity

# GAZEL® Metal Gasket Face Seal Fittings

## GLANDS

## EMBOUTS

## STUTZEN

### MINI SHORT FEMALE GLAND EMBOUT FEMELLE COURT MINI MINI KURZSTUTZEN, MIT WULST

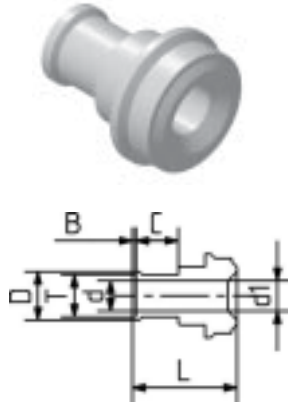

T1 Tube O.D.	T Tube O.D.	Part Number	L		d1		d		D	B	C		Nominal Wall Thickness		Working Pressure	
			mm	INCH	mm	INCH	mm	INCH			mm	INCH	mm	INCH	PSIG	BAR
<b>Fractional</b>																
1/4"	1/8"	MG.EFC 14 18	15,6	0,61	4,6	0,18	2,1	0,08	3,8	0,3	6,4	0,25	0,71	0,028	5100	350
1/4"	1/4"	MG.EFC 14	15,7	0,62	4,6	0,18	4,6	0,18	7,4	0,5	6,4	0,25	0,89	0,035	5100	350
3/8"	3/8"	MG.EFC 38	16,5	0,65	7,7	0,30	7,7	0,30	10,5	0,8	6,4	0,25	0,89	0,035	3300	220
1/2"	1/2"	MG.EFC 12	16,7	0,66	10,2	0,40	10,2	0,40	14,0	1,0	6,4	0,25	1,25	0,049	3500	240

### MINI FEMALE GLAND EMBOUT FEMELLE MINI MINI STUTZEN, MIT WULST

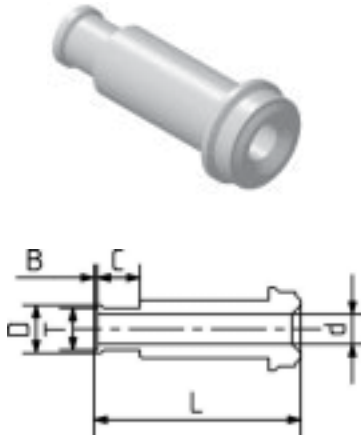

T Tube O.D.	Part Number	L		d		D	B	C		Nominal Wall Thickness		Working Pressure	
		mm	INCH	mm	INCH			mm	INCH	mm	INCH	PSIG	BAR
<b>Fractional</b>													
1/8"	MG.EF 18	23,8	0,94	2,1	0,08	3,8	0,5	6,4	0,25	0,71	0,028	5100	350
1/4"	MG.EF 14	31,0	1,22	4,6	0,18	7,4	0,5	6,4	0,25	0,89	0,035	5100	350
1/2"	MG.EF 12	33,8	1,33	10,2	0,40	14,0	1,0	6,4	0,25	1,3	0,049	3500	240

### AUTOMATIC TUBE WELD REDUCING FEMALE GLAND EMBOUT REDUCTION POUR SOUDURE AUTOMATIQUE BOUT A BOUT REDUZIERSTUTZEN MIT STUMPFSCHEISSANSCHLUSS FÜR AUTOMATISCHE STUMPFSCHEISSUNG, MIT WULST

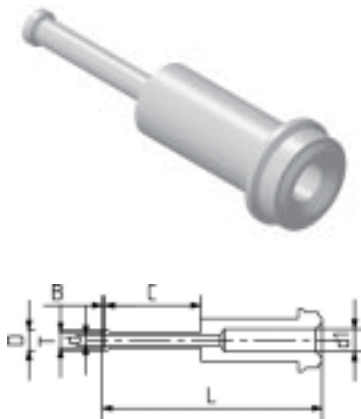

T1 Tube O.D.	T Tube O.D.	Part Number	L		d1		d		D	B	C		Nominal Wall Thickness		Working Pressure	
			mm	INCH	mm	INCH	mm	INCH			mm	INCH	mm	INCH	PSIG	BAR
<b>Fractional</b>																
1/4"	1/8"	EFR 14 18 AB	43,5	1,71	4,6	0,18	2,1	0,08	3,8	0,5	19,1	0,75	0,71	0,028	5100	350
1/4"	1/8"	EFCR 14 18 AB	28,2	1,11	4,6	0,18	2,1	0,08	3,8	0,5	19,1	0,75	0,71	0,028	5100	350
1/2"	1/4"	EFR 12 14 AB	46,2	1,82	10,2	0,40	4,6	0,18	7,4	0,5	19,1	0,75	0,89	0,035	3500	240
1/2"	3/8"	EFR 12 38 AB	46,2	1,82	10,2	0,40	7,7	0,30	10,5	0,8	19,1	0,75	0,89	0,035	3500	240

# GAZEL® Metal Gasket Face Seal Fittings

GLANDS

EMBOUS

STUTZEN

**AUTOMATIC TUBE WELD SHORT FEMALE GLAND**  
**EMBOU FEMELLE COURT POUR SOUDURE AUTOMATIQUE BOUT A BOUT**  
**VERKÜRZTER STUTZEN FÜR AUTOMATISCHES SCHWEISSEN, MIT WULST**

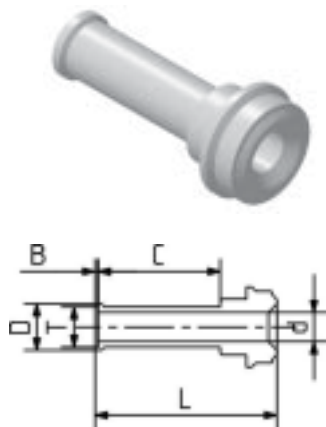

T Tube O.D.	Part Number	L		d		D	B	C		Nominal Wall Thickness		Working Pressure	
		mm	INCH	mm	INCH			mm	mm	INCH	mm	INCH	PSIG
<b>Fractional</b>													
1/4"	EFC 14 AB	28,4	1,12	4,6	0,18	7,4	0,5	19,1	0,75	0,89	0,035	5100	350
3/8"	EFC 38 AB	29,2	1,15	7,7	0,30	10,5	0,8	19,1	0,75	0,89	0,035	3300	220
1/2"	EFC 12 AB	29,5	1,16	10,2	0,40	14,0	1,0	19,1	0,75	1,25	0,049	3500	240
<b>Metric</b>													
6mm	EFC 6M AB	30,0	1,18	4,0	0,16	6,9	0,5	19,1	0,75	1,0	0,039	6800	460
8mm	EFC 8M AB	30,2	1,19	6,0	0,24	8,9	0,8	19,1	0,75	1,0	0,039	4800	330
10mm	EFC 10M AB	31,0	1,22	8,0	0,31	10,9	0,8	19,1	0,75	1,0	0,039	3500	240
12mm	EFC 12M AB	30,5	1,20	10,0	0,39	13,2	1,0	19,1	0,75	1,0	0,039	3100	210
<b>Jis</b>													
1/4"	EFC 14J AB	28,4	1,12	4,4	0,17	7,4	0,5	19,1	0,75	1,0	0,039	5600	380
3/8"	EFC 38J AB	29,2	1,15	7,5	0,29	10,5	0,8	19,1	0,75	1,0	0,039	3500	240

**AUTOMATIC TUBE WELD FEMALE GLAND**  
**EMBOU FEMELLE POUR SOUDURE AUTOMATIQUE BOUT A BOUT**  
**STUTZEN FÜR AUTOMATISCHES SCHWEISSEN, MIT WULST**

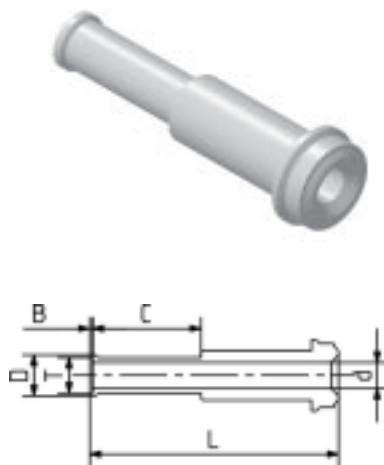

T Tube O.D.	Part Number	L		d		D	B	C		Nominal Wall Thickness		Working Pressure	
		mm	INCH	mm	INCH			mm	mm	INCH	mm	INCH	PSIG
<b>Fractional</b>													
1/4"	EF 14 AB	43,7	1,72	4,6	0,18	7,4	0,5	19,1	0,75	0,89	0,035	5100	350
3/8"	EF 38 AB	46,2	1,82	7,7	0,30	10,5	0,8	19,1	0,75	0,89	0,035	3300	220
1/2"	EF 12 AB	46,5	1,83	10,2	0,40	14,0	1,0	19,1	0,75	1,25	0,049	3500	240
3/4"	EF 34 AB	52,6	2,07	16,5	0,65	20,3	1,0	19,1	0,75	1,25	0,049	2400	160
1"	EF 100 AB	65,3	2,57	22,1	0,87	26,9	1,0	24,4	0,96	1,65	0,065	2400	160
<b>Metric</b>													
6mm	EF 6M AB	43,7	1,72	4,0	0,16	6,9	0,5	19,1	0,75	1,0	0,039	6800	460
8mm	EF 8M AB	44,0	1,73	6,0	0,24	8,9	0,8	19,1	0,75	1,0	0,039	4800	330
12mm	EF 12M AB	46,5	1,83	10,0	0,39	13,2	1,0	19,1	0,75	1,0	0,039	3500	240
18mm	EF 18M AB	52,6	2,07	15,0	0,59	19,2	1,0	19,1	0,75	1,5	0,059	3100	210
<b>Jis</b>													
1/4"	EF 14J AB	43,7	1,72	4,4	0,17	7,4	0,5	19,1	0,75	1,0	0,039	5600	380
3/8"	EF 38J AB	46,2	1,82	7,5	0,29	10,5	0,8	19,1	0,75	1,0	0,039	3500	240

# GAZEL® Metal Gasket Face Seal Fittings

## UNIONS

## UNIONS

## GERADE VERBINDER

### DOUBLE MALE UNION UNION DOUBLE MALE EINSCHRAUBVERBINDUNG

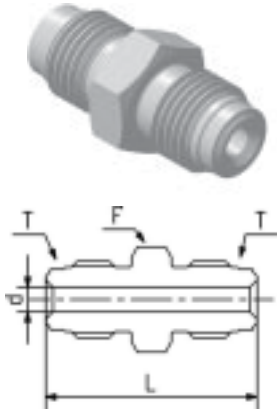

T Tube O.D.	Part Number ①	L		d		F	Working Pressure	
		mm	INCH	mm	INCH		PSIG	BAR
<b>Fractional</b>								
1/8"	UM 18	28,7	1,13	2,1	0,08	9,5	9000	620
1/4"	UM 14	39,4	1,55	4,6	0,18	15,9	8000	550
1/2"	UM 12	46,7	1,84	10,2	0,40	23,8	3500	240
3/4"	UM 34	62,0	2,44	16,5	0,65	33,3	3000	200
1"	UM 100	65,8	2,59	22,1	0,87	41,3	2400	160

### DOUBLE MALE REDUCING UNION UNION REDUCTION DOUBLE MALE REDUZIER-VERBINDUNG

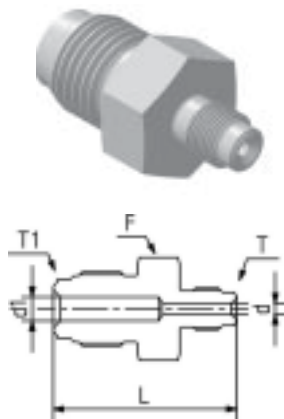

T1 Tube O.D.	T Tube O.D.	Part Number ①	L		d1		d		F	Working Pressure	
			mm	INCH	mm	INCH	mm	INCH		PSIG	BAR
<b>Fractional</b>											
1/4"	1/8"	DMRU 14 18	34,8	1,37	2,1	0,08	4,6	0,18	15,9	8000	550
1/2"	1/4"	DMRU 12 14	43,4	1,71	4,6	0,18	10,2	0,40	23,8	3500	240

### STRAIGHT THREAD MALE CONNECTOR, O-RING RACCORD MALE FILETE CYLINDRIQUE EINSCHRAUBVERBINDUNG MIT O-RING AUSSENGEWINDETEIL

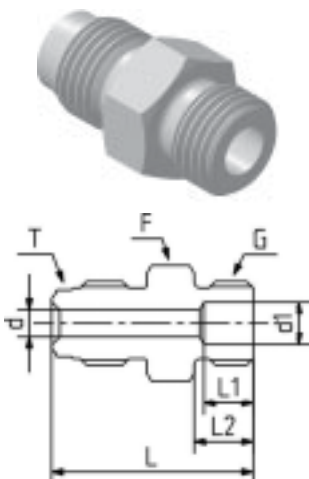

T Tube O.D.	Part Number ① ②	L		L1	L2	d1		d		F	G	O-RING Size N°	Working Pressure	
		mm	INCH			mm	mm	mm	INCH				mm	INCH
<b>Fractional</b>														
1/4"	STMC 14	33,8	1,33	6,4	9,9	7,1	0,28	4,6	0,18	19,1	9-16"-18	FLUOROCARBON 906	4500	310
1/2"	STMC 12 12	42,2	1,66	10,2	12,7	15	0,59	7,1	0,28	25,4	7/8"-14	FLUOROCARBON 910	3500	240
1/2"	STMC 12 14	37,6	1,48	6,4	9,9	7,1	0,28	7,1	0,28	23,8	9/16"-18	FLUOROCARBON 906	3500	240

① These fittings should be assembled only with rotating male or female nuts.  
② O-Rings Fluorocarbon FKM standard, other materials on request

# GAZEL® Metal Gasket Face Seal Fittings

## UNIONS

## UNIONS

## GERADE VERBINDER

### REDUCING ADAPTER ADAPTATEUR REDUCING REDUZIERADAPTER

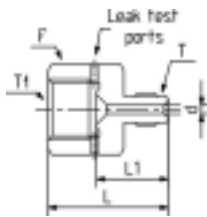

T1 Tube O.D.	T Tube O.D.	Part Number ①	L		L1	d		F	Working Pressure	
			mm	INCH		mm	mm		INCH	mm
<b>Fractional</b>										
1/4"	1/8"	RA 14 18	30,2	1,19	17,5	2,1	0,08	19,1	8000	550
1/2"	1/4"	RA 12 14	35,8	1,41	21,6	4,6	0,18	27,0	3500	240

### REDUCING BUSHING RACCORD REDUCTEUR REDUZIERADAPTER

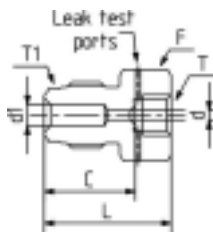

T1 Tube O.D.	T Tube O.D.	Part Number ①	L		L1	d		F	Working Pressure	
			mm	INCH		mm	mm		INCH	mm
<b>Fractional</b>										
1/4"	1/8"	RB 14 18	26,9	1,06	19,3	3,6	0,14	15,9	8000	550
1/2"	1/4"	RB 12 14	35,8	1,41	23,1	6,3	0,25	23,8	3500	240

### MALE FEMALE UNION UNION MALE FEMELLE EINSCHRAUB- AUFSCHRAUBVERBINDUNG

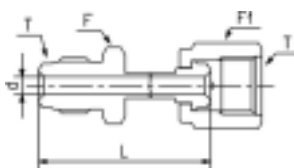

T Tube O.D.	Part Number ①	L		d		F	F1	Working Pressure	
		mm	INCH	mm	INCH			mm	mm
<b>Fractional</b>									
1/4"	U 14 FM	43,4	1,71	4,6	0,18	15,9	19,1	5100	350

① These fittings should be assembled only with rotating male or female nuts.

# GAZEL® Metal Gasket Face Seal Fittings

## UNIONS

## UNIONS

## GERADE VERBINDER

### COUPLING UNION DOUBLE FEMELLE AUFSCHRAUBVERBINDUNG

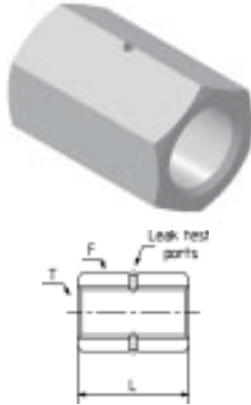

T Tube O.D.	Part Number ①	L		F
		mm	INCH	mm
<b>Fractional</b>				
1/8"	CG 18	16,8	0,66	11,1
1/4"	CG 14	30,2	1,19	19,1
1/2"	CG 12	33,3	1,31	27,0
3/4"	CG 34	42,7	1,68	38,1
1"	CG 100	51,8	2,04	44,5

### DOUBLE FEMALE REDUCING UNION UNION REDUCTION DOUBLE FEMELLE REDUZIER-AUFSCHRAUBVERBINDUNG

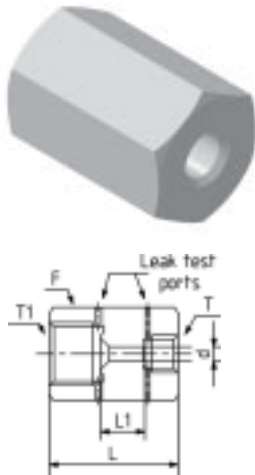

T1 Tube O.D.	T Tube O.D.	Part Number ①	L		L1	d		F	Working Pressure	
			mm	INCH	mm	mm	INCH	mm	PSIG	BAR
<b>Fractional</b>										
1/4"	1/8"	DFRU 14 18	29,5	1,16	9,1	3,3	0,13	19,1	8000	550
1/2"	1/4"	DFRU 12 14	35,8	1,41	8,9	6,3	0,25	27,0	3500	240

### DOUBLE FEMALE UNION UNION DOUBLE FEMELLE AUFSCHRAUBVERBINDUNG, DREHBAR

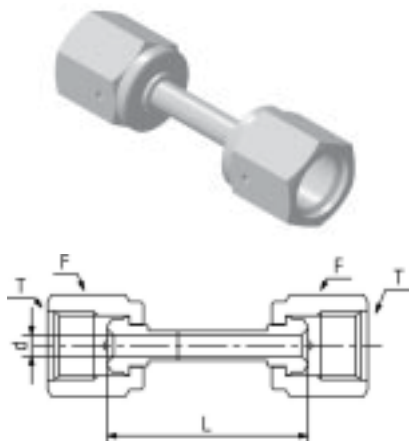

T Tube O.D.	Part Number ②	L		d		F	Working Pressure	
		mm	INCH	mm	INCH	mm	PSIG	BAR
<b>Fractional</b>								
1/4"	U 14 F	43,4	1,71	4,6	0,18	19,1	5100	350
1/2"	U 12 F	46,7	1,84	10,2	0,40	27,0	3500	240

① These fittings should be assembled only with rotating male or female nuts.

② On request it can be delivered with a double female reducing union 1/2" F and 1/4" F (Part number: UR 12 14 F)



# GAZEL® Metal Gasket Face Seal Fittings

## UNIONS

## UNIONS

## GERADE VERBINDER

### MALE CONNECTOR CONNECTEUR MALE EINSCHRAUBVERBINDUNG FÜR NPT

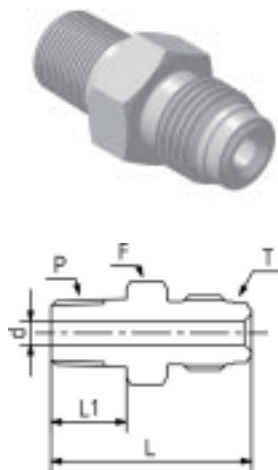

T Tube O.D.	P NPT	Part Number ①	L		L1	d		F	Working Pressure		
			mm	INCH		mm	mm		INCH	mm	PSIG
<b>Fractional</b>											
1/8"	1/16"	UM 18 NPT 116 ②	27,2	1,07	9,6	2,1	0,08	9,5	9000	620	
1/8"	1/8"	NPT 18	27,2	1,07	9,6	2,1	0,08	9,5	9000	620	
1/4"	1/8"	UM 14 NPT 18	33,3	1,31	9,6	4,6	0,18	15,9	8000	550	
1/4"	1/4"	NPT 14	37,8	1,49	14,2	4,6	0,18	15,9	8000	550	
1/2"	3/8"	UM 12 NPT 38	41,9	1,65	14,2	9,7	0,38	23,8	3500	240	
1/2"	1/2"	NPT 12	46,7	1,84	19,1	10,2	0,40	23,8	3500	240	
3/4"	3/4"	NPT 34	55,6	2,19	19,1	15,8	0,62	33,3	3000	200	
1"	1"	NPT 100	62,7	2,47	23,9	22,3	0,88	41,3	2400	160	

### FEMALE CONNECTOR CONNECTEUR FEMELLE EINSCHRAUBVERBINDUNG FÜR NPT, DREHBAR

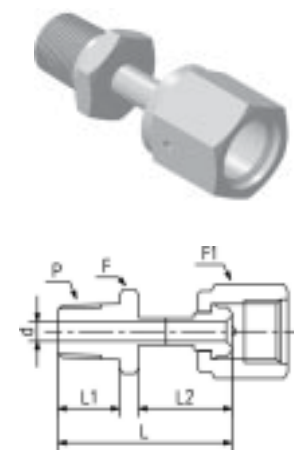

T Tube O.D.	P NPT	Part Number	L		L1	L2	d		F	F1	Working Pressure	
			mm	INCH			mm	mm			mm	INCH
<b>Fractional</b>												
1/4"	1/8"	UF 14 NPT 18	40,1	1,58	9,6	24,1	4,6	0,18	15,9	19,1	5100	350
1/4"	1/4"	NPT 14 F	45,5	1,79	14,2	23,4	4,6	0,18	15,9	19,1	5100	350
1/2"	3/8"	UF 12 NPT 38	48,0	1,89	14,2	25,4	9,9	0,39	23,8	27,0	3500	240
1/2"	1/2"	NPT 12 F	53,1	2,09	19,1	25,6	9,9	0,39	23,8	27,0	3500	240

① These fittings should be assembled only with rotating male or female nuts

② Minimum quantity

# GAZEL® Metal Gasket Face Seal Fittings

## UNIONS

## UNIONS

## GERADE VERBINDER

FEMALE CONNECTOR  
RACCORD FEMELLE  
AUFSCHRAUBVERBINDUNG FÜR NPT

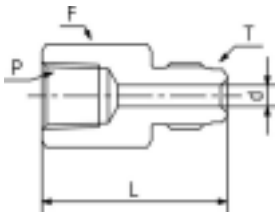

T Tube O.D.	P NPT	Part Number ①	L		d		F	Working Pressure	
			mm	INCH	mm	INCH		mm	PSIG
<b>Fractional</b>									
1/8"	1/16"	UM 18 NPTF 116	27,9	1,10	2,3	0,09	11,1	6700	460
1/8"	1/8"	UM 18 NPTF 18	30,2	1,19	2,3	0,09	14,3	6500	440
1/4"	1/8"	UM 14 NPTF 18	35,8	1,41	4,6	0,18	15,9	8000	550
1/4"	1/4"	UM 14 NPTF 14	39,1	1,54	4,6	0,18	19,1	6600	450
1/2"	3/8"	UM 12 NPTF 38	44,7	1,76	10,2	0,40	23,8	3500	240
1/2"	1/2"	UM 12 NPTF 12	50,5	1,99	10,2	0,40	27,0	3500	240
3/4"	3/4"	UM 34 NPTF 34	59,7	2,36	15,7	0,62	33,3	3000	200
1"	1"	UM 100 NPTF 100	63,8	2,51	22,1	0,87	41,3	2400	160

FEMALE CONNECTOR  
ADAPTEUR FEMELLE  
AUFSCHRAUBVERBINDUNG FÜR NPT, DREHBAR

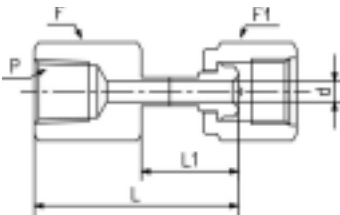

T Tube O.D.	P NPT	Part Number	L		L1	d		F	F1	Working Pressure	
			mm	INCH	mm	mm	INCH	mm	mm	PSIG	BAR
<b>Fractional</b>											
1/4"	1/4"	UF 14 NPTF 14	45,2	1,78	23,4	4,6	0,18	19,1	19,1	5100	350
1/2"	3/8"	UF 12 NPTF 38	49,5	1,95	26,9	10,2	0,40	27,0	27,0	3300	220
1/2"	1/2"	UF 12 NPTF 12	55,4	2,18	26,4	10,2	0,40	27,0	27,0	3500	240

① These fittings should be assembled only with rotating male or female nuts

# GAZEL® Metal Gasket Face Seal Fittings

UNIONS

UNIONS

GERADE VERBINDER

**TUBE FITTING CONNECTOR  
UNION MALE RACCORD DOUBLE BAGUES  
EINSCHRAUBVERBINDUNG MIT DOPPELRINGVERSCHRAUBUNG**

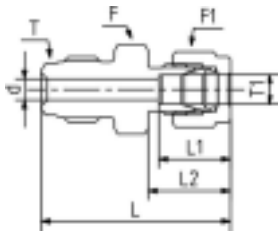

T Tube O.D.	T1 Tube O.D.	Part Number ①	L		L1	L2	d		F	F1	Working Pressure	
			mm	INCH			mm	INCH			PSIG	BAR
<b>Fractional</b>												
1/4"	1/8"	UM 14 18 DB	38,9	1,53	12,7	15,2	2,1	0,08	15,9	11,1	8000	550
1/4"	1/4"	UM 14 14 DB	41,1	1,62	15,2	17,8	4,6	0,18	15,9	14,3	8000	550
1/2"	3/8"	UM 12 38 DB	46,7	1,84	16,8	19,3	7,7	0,30	23,8	17,5	3500	240
1/2"	1/2"	UM 12 12 DB	49,5	1,95	22,9	21,8	10,2	0,40	23,8	22,2	3500	240

**TUBE FITTING CONNECTOR  
UNION FEMELLE RACCORD DOUBLE BAGUES  
AUFSCHRAUBVERBINDUNG**

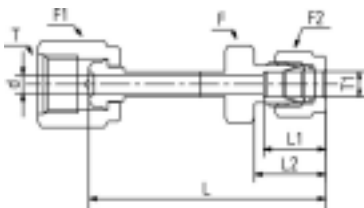

T1 Tube O.D.	T Tube O.D.	Part Number	L		L1	L2	d		F	F1	F2	Working Pressure	
			mm	INCH			mm	INCH				PSIG	BAR
<b>Fractional</b>													
1/4"	1/4"	UF 14 14 DB	49,3	1,94	15,2	17,8	4,6	0,18	15,9	19,1	14,3	5100	350
1/2"	3/8"	UF 12 38 DB	50,0	1,97	16,8	19,3	7,7	0,30	23,8	27,0	17,5	3300	220
1/2"	1/2"	UF 12 12 DB	56,6	2,23	22,9	21,8	10,2	0,40	23,8	27,0	22,2	3500	240

① These fittings should be assembled only with rotating male or female nuts

# GAZEL® Metal Gasket Face Seal Fittings

## BULKHEAD UNIONS

## TRAVERSEE DE CLOISON

## SCHOTTEINSCHRAUBVERBINDUNG

### BULKHEAD UNION TRAVERSEE DE CLOISON SCHOTTEINSCHRAUBVERBINDUNG

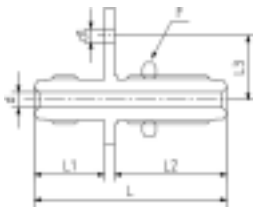

T Tube O.D.	Part Number ①	L		L1	L2	L3	d		d1	F	Panel hole size mm	Working Pressure	
		mm	INCH	mm	mm	mm	mm	INCH	mm	mm		PSIG	BAR
<b>Fractional</b>													
1/4"	BUP 14	56,6	2,23	20,5	33,0	19,0	4,6	0,18	4,0	19,1	15,1	8000	550

### BULKHEAD UNION TRAVERSEE DE CLOISON SCHOTTEINSCHRAUBVERBINDUNG

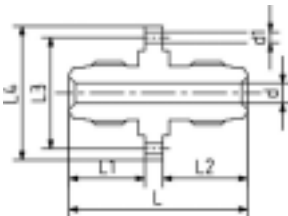

T Tube O.D.	Part Number ①	L		L1	L2	L3	L4	d		d1	Working Pressure	
		mm	INCH	mm	mm	mm	mm	mm	INCH	mm	PSIG	BAR
<b>Fractional</b>												
1/4"	TC 14	39,8	1,57	16,8	18,8	30,0	20,0	4,6	0,18	3,5	8000	550

### BULKHEAD UNION TRAVERSEE DE CLOISON SCHOTTEINSCHRAUBVERBINDUNG

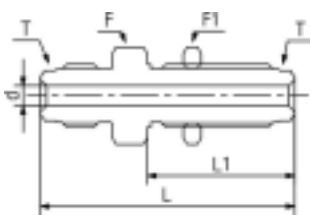

T Tube O.D.	Part Number ①	L		L1	d		F	F1	Panel hole size mm	Max panel thickness		Working Pressure	
		mm	INCH	mm	mm	INCH	mm	mm		mm	INCH	PSIG	BAR
<b>Fractional</b>													
1/4"	BU 14	56,6	2,23	33,0	4,6	0,18	19,1	19,1	15,1	11,1	0,44	8000	550
1/4"	BUS 14	46,2	1,82	25,1	4,6	0,18	19,1	19,1	15,1	3,3	0,13	8000	550
1/2"	BU 12	66,3	2,61	37,6	10,2	0,40	27,0	27,0	23,0	12,7	0,50	3500	240
1/2"	BUS 12	54,4	2,14	28,2	10,2	0,40	27,0	27,0	23,0	3,3	0,13	3500	240

① These fittings should be assembled only with rotating male or female nuts

# GAZEL® Metal Gasket Face Seal Fittings

## BULKHEAD UNIONS

## TRAVERSEE DE CLOISON

## SCHOTTEINSCHRAUBVERBINDUNG

### BUTTWELD BULKHEAD UNION

TRAVERSEE DE CLOISON POUR SOUDURE AUTOMATIQUE BOUT A BOUT  
SCHOTTEINSCHRAUBVERBINDUNG, MIT SCHWEISSSTUTZEN

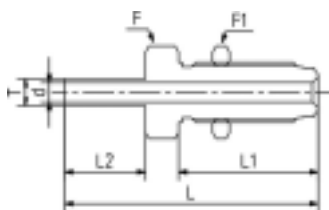

T Tube O.D.	Part Number ①	L		L1		d		C		F	F1	Panel hole size mm	Max panel thickness mm	Working Pressure	
		mm	INCH	mm	mm	INCH	mm	INCH	mm	mm	PSIG			BAR	
<b>Fractional</b>															
1/4"	BU 14 ABW	59,9	2,36	33,0	4,6	0,18	19,1	0,75	19,1	19,1	15,1	11,1	5100	350	
1/4"	BUS 14 ABW	49,5	1,95	25,1	4,6	0,18	19,1	0,75	19,1	19,1	15,1	3,3	5100	350	

### BULKHEAD NPT UNION

TRAVERSEE DE CLOISON NPT  
NPT SCHOTTEINSCHRAUBVERBINDUNG

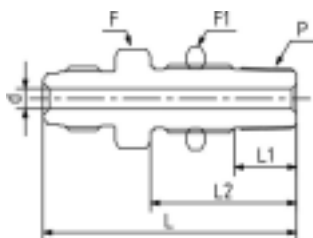

T1 Tube O.D.	P NPT	Part Number ①	L		d		L1	L2	F	F1	Panel hole size mm	Max panel thickness mm	Working Pressure		
			mm	INCH	mm	INCH	mm	mm	mm	mm			PSIG	BAR	
<b>Fractional</b>															
1/4"	1/4"	BU 14 NPT 14	56,1	2,21	4,6	0,18	14,2	31,5	23,8	23,8	16,7	9,7	8000	550	
1/2"	1/4"	BU 12 NPT 14	59,4	2,34	10,2	0,40	14,2	31,5	23,8	23,8	16,7	9,7	3500	240	

### TUBE FITTING BULKHEAD CONNECTOR

TRAVERSEE DE CLOISON RACCORDS DOUBLE BAGUES  
SCHOTTEINSCHRAUBVERBINDUNG, MIT DOPPELRINGVERSCHRAUBUNG

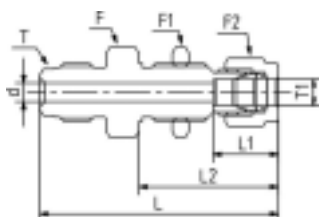

T Tube O.D.	T1 Tube O.D.	Part Number ①	L		L1	L2	d		F	F1	F2	Working Pressure	
			mm	INCH	mm	mm	mm	INCH	mm	mm	mm	PSIG	BAR
<b>Fractional</b>													
1/4"	1/4"	BU 14 14 DB	57,2	2,25	15,2	33,5	4,6	0,18	19,1	19,1	14,3	5100	350
1/4"	1/4"	BUS 14 14 DB	47,8	1,88	15,2	26,7	4,6	0,18	19,1	19,1	14,3	5100	350
1/2"	3/8"	BU 12 38 DB	64,5	2,54	16,8	36,8	7,7	0,30	23,8	23,8	17,5	3300	220
1/2"	1/2"	BU 12 12 DB	69,6	2,74	22,9	41,9	10,2	0,40	23,8	23,8	22,2	3500	240

① These fittings should be assembled only with rotating male or female nuts

# GAZEL® Metal Gasket Face Seal Fittings

## ELBOWS

## COUDES

## WINKEL

### MALE NPT ELBOW COUDE MALE EINSCHRAUBWINKEL

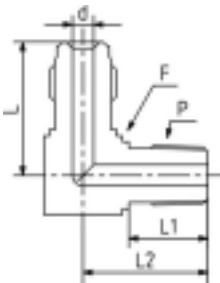

T Tube O.D.	P NPT	Part Number ①	L		L1	L2	d		F	Working Pressure	
			mm	INCH	mm	mm	mm	INCH	mm	PSIG	BAR
<b>Fractional</b>											
1/4"	1/8"	E 14 NPT 18	27,2	1,07	9,6	22,1	4,6	0,18	17,0	8000	550
1/4"	1/4"	E 14 NPT 14	27,2	1,07	14,2	26,7	4,6	0,18	17,0	8000	550
1/2"	3/8"	E 12 NPT 38	36,8	1,45	14,2	32,0	10,2	0,40	24,0	3500	240
1/2"	1/2"	E 12 NPT 12	36,8	1,45	19,1	36,8	10,2	0,40	24,0	3500	240

### UNION ELBOW COUDE WINKELSTÜCK

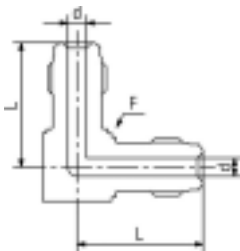

T Tube O.D.	Part Number ①	L		d		F	Working Pressure	
		mm	INCH	mm	INCH	mm	PSIG	BAR
<b>Fractional</b>								
1/8"	E 18	22,6	0,89	2,1	0,08	12	9000	620
1/4"	E 14	27,2	1,07	4,6	0,18	17	8000	550
1/2"	E 12	36,8	1,45	10,2	0,40	24	3500	240
3/4"	E 34	48,8	1,92	16,5	0,65	35	3000	200
1"	E 100	50,8	2,00	22,1	0,87	41	2400	160

① These fittings should be assembled only with rotating male or female nuts

# GAZEL® Metal Gasket Face Seal Fittings

## TEES

## TES

## T-STÜCKE

UNION TEE  
TE  
EINSCHRAUB-T-STÜCK

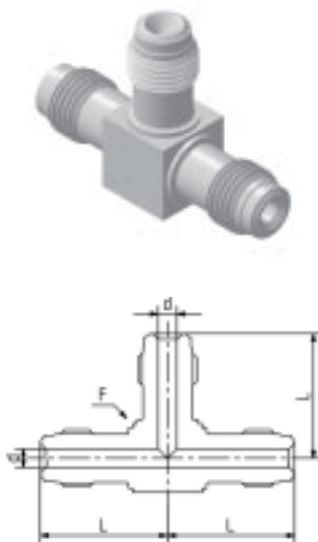

T Tube O.D.	Part Number ①	L		d		F mm	Working Pressure	
		mm	INCH	mm	INCH		PSIG	BAR
<b>Fractional</b>								
1/8"	T 18	22,6	0,89	2,1	0,08	12	9000	620
1/4"	T 14	27,2	1,07	4,6	0,18	17	8000	550
1/2"	T 12	36,8	1,45	10,2	0,40	24	3500	240
3/4"	T 34	48,8	1,92	16,5	0,65	35	3000	200
1"	T 100	50,8	2,00	22,1	0,87	41	2400	160

## CROSSES

## CROIX

## KREUZSTÜCKE

UNION CROSS  
CROIX  
KREUZSTÜCK

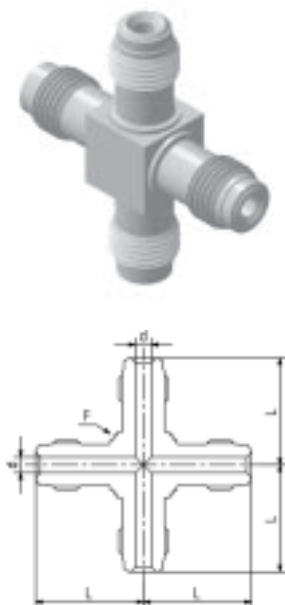

T Tube O.D.	Part Number ①	L		d		F mm	Working Pressure	
		mm	INCH	mm	INCH		PSIG	BAR
<b>Fractional</b>								
1/8"	C 18	22,6	0,89	2,1	0,08	12	9000	620
1/4"	C 14	27,2	1,07	4,6	0,18	17	8000	550
1/2"	C 12	36,8	1,45	10,2	0,40	24	3500	240
3/4"	C 34	48,8	1,92	16,5	0,65	35	3000	200
1"	C 100	50,8	2,00	22,1	0,87	41	2400	160

① These fittings should be assembled only with rotating male or female nuts

# GAZEL® Space Savers Fittings

## TEES

## TES

## T-STÜCKE

ELBOW SERIE ED  
COUDE SERIE ED  
WINKELSTÜCK SERIE ED

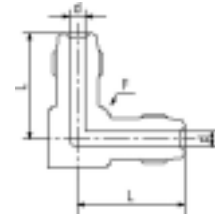

T tube O.D.	Part Number	L		d		F	Working Pressure		
		mm	INCH	mm	INCH		PSIG	BAR	
<b>Fractional</b>									
1/4"	ED 14 2M	31,0	1,22	4,6	0,18	17	8000	550	

ELBOW SERIE ED  
COUDE SERIE ED  
WINKELSTÜCK SERIE ED

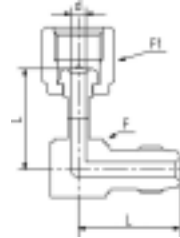

T tube O.D.	Part Number	L		d		F	F1	Working Pressure	
		mm	INCH	mm	INCH			PSIG	BAR
<b>Fractional</b>									
1/4"	ED 14 FM	31,0	1,22	4,6	0,18	17	19,1	5100	350

ELBOW SERIE ED  
COUDE SERIE ED  
WINKELSTÜCK SERIE ED

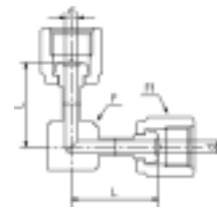

T tube O.D.	Part Number	L		d		F	F1	Working Pressure	
		mm	INCH	mm	INCH			PSIG	BAR
<b>Fractional</b>									
1/4"	ED 14 2F	31,0	1,22	4,6	0,18	17	19,1	5100	350
1/4"	EDCA 14 2F	25,4	1,00	4,6	0,18	7,9	19,1	5100	350



# GAZEL® Space Savers Fittings

## TEES

## TES

## T-STÜCKE

ELBOW SERIE EX  
COUDE SERIE EX  
WINKELSTÜCK SERIE EX

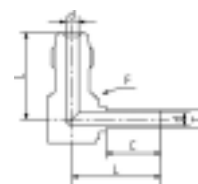

T Tube O.D.	Part Number	L		d	C		F	Working Pressure		
		mm	INCH	mm	mm	INCH	mm	PSIG	BAR	
<b>Fractional</b>										
1/4"	EX M.14W ①	31,0	1,22	4,6	19,1	0,75	17,0	5100	350	

MINI ELBOW SERIE MG.EX  
COUDE MINI SERIE MG.EX  
MINI WINKELSTÜCK SERIE MG.EX

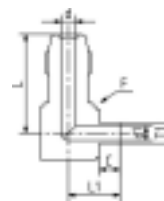

T1 Tube O.D.	T Tube O.D.	Part Number	L		L1	d1	d	C		F	Workin Pressu	
			mm	INCH	mm	mm	mm	mm	INCH	mm	PSIG	BAR
<b>Fractional</b>												
1/4"	1/4"	MG.EX M.14	31,0	1,22	15,9	4,6	4,6	6,4	0,25	17,0	5100	350
3/8"	1/4"	MG.EX M.38	31,0	1,22	15,9	7,7	4,6	6,4	0,25	17,0	3300	230
1/2"	1/4"	MG.EX M.12	31,0	1,22	15,9	10,2	4,6	6,4	0,25	17,0	3500	248

ELBOW SERIES EX  
COUDE SERIE EX  
WINKELSTÜCK SERIE EX

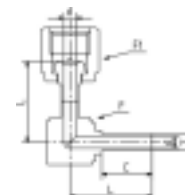

T Tube O.D.	Part Number	L		d	C		F	F1	Working Pressure	
		mm	INCH	mm	mm	INCH	mm	mm	PSIG	BAR
<b>Fractional</b>										
1/4"	EX F.14W ①	31,0	1,22	4,6	19,1	0,75	17,0	19,1	5100	350

MINI ELBOW SERIE MG.EX  
COUDE MINI SERIE MG.EX  
MINI WINKELSTÜCK SERIE MG.EX DREHBAR

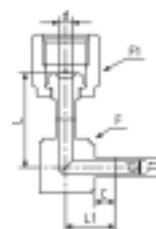

T1 Tube O.D.	T Tube O.D.	Part Number	L		L1	d1	d	C		F	F1
			mm	INCH	mm	mm	mm	mm	INCH	mm	mm
<b>Fractional</b>											
1/4"	1/4"	MG.EX F.14	31,0	1,22	15,9	4,6	4,6	6,4	0,25	17,0	17,0
3/8"	1/4"	MG.EX F.38	31,0	1,22	15,9	7,7	4,6	6,4	0,25	17,0	17,0
1/2"	1/4"	MG.EX F.12	31,0	1,22	15,9	10,2	4,6	6,4	0,25	17,0	17,0

① On request: it can be delivered with shoulder (Example: EX M.14).

# GAZEL® Space Savers Fittings

## TEES

## TES

## T-STÜCKE

TEE SERIE TD  
TE SERIE TD  
EINSCHRAUB-T-STÜCK SERIE TD

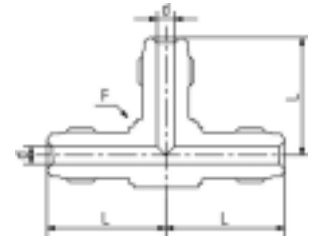

T Tube O.D.	Part Number	L		d		F	Working Pressure		
		mm	INCH	mm	INCH		PSIG	BAR	
<b>Fractional</b>									
1/4"	TD 14 3M	31,0	1,22	4,6	0,18	17	8000	550	

TEE SERIE TD  
TE SERIE TD  
T-STÜCK SERIE TD

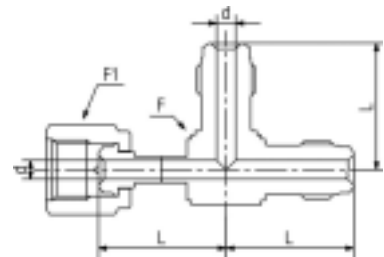

T Tube O.D.	Part Number	L		d		F	F1	Working Pressure	
		mm	INCH	mm	INCH			PSIG	BAR
<b>Fractional</b>									
1/4"	TD 14 F.2M	31,0	1,22	4,6	0,18	17	19,1	5100	350

TEE SERIE TD  
TE SERIE TD  
T-STÜCK SERIE TD

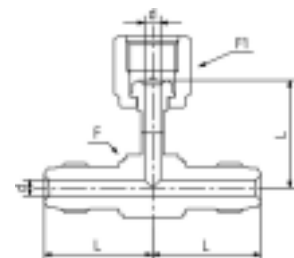

T Tube O.D.	Part Number	L		d		F	F1	Working Pressure	
		mm	INCH	mm	INCH			PSIG	BAR
<b>Fractional</b>									
1/4"	TD 14 MFM	31,0	1,22	4,6	0,18	17	19,1	5100	350

# GAZEL® Space Savers Fittings

## TEES

## TES

## T-STÜCKE

TEE SERIE TD  
TE SERIE TD  
T-STÜCK SERIE TD

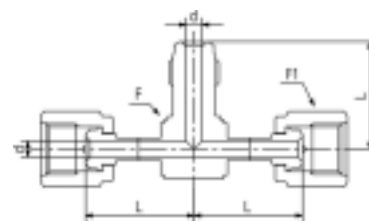

T Tube O.D.	Part Number	L		d		F	F1	Working Pressure	
		mm	INCH	mm	INCH			PSIG	BAR
<b>Fractional</b>									
1/4"	TD 14 FMF	31,0	1,22	4,6	0,18	17	19,1	5100	350

TEE SERIE TD  
TE SERIE TD  
T-STÜCK SERIE TD

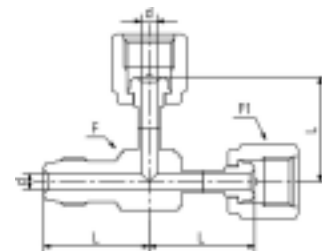

T Tube O.D.	Part Number	L		d		F	F1	Working Pressure	
		mm	INCH	mm	INCH			PSIG	BAR
<b>Fractional</b>									
1/4"	TD 14 M.2F	31,0	1,22	4,6	0,18	17	19,1	5100	350

TEE SERIE TD  
TE SERIE TD  
T-STÜCK SERIE TD

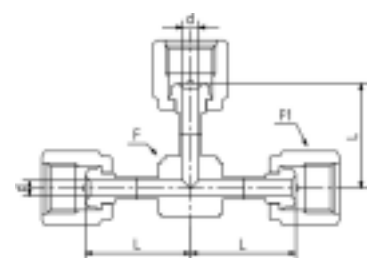
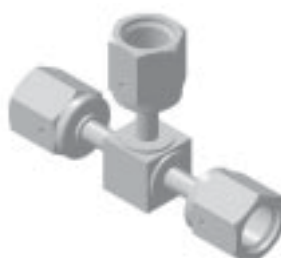

T Tube O.D.	Part Number	L		d		F	F1	Working Pressure	
		mm	INCH	mm	INCH			PSIG	BAR
<b>Fractional</b>									
1/4"	TD 14 3F	31,0	1,22	4,6	0,18	17	19,1	5100	350
1/4"	TDCA 14 3F	25,4	1,00	4,6	0,18	7,9	19,1	5100	350

# GAZEL® Space Savers Fittings

## TEES

## TES

## T-STÜCKE

TEE SERIE TX  
TE SERIE TX  
T-STÜCK SERIE TX

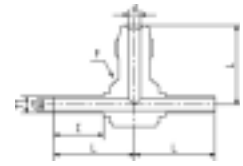

T1 Tube O.D.	T Tube O.D.	Part Number ①	L		d1 mm	d mm	C		F mm	Working Pressure	
			mm	INCH			mm	INCH		PSIG	BAR
<b>Fractional</b>											
1/4"	1/4"	TX 14W.M.14W	31,0	1,22	4,6	4,6	19,1	0,75	17	5100	350
3/8"	1/4"	TX 38W.M.38W	31,0	1,22	7,7	4,6	19,1	0,75	17	3300	220
1/2"	1/4"	TX 12W.M.12W	31,0	1,22	10,2	4,6	19,1	0,75	17	3500	240

MINI TEE SERIE MG.TX  
TE MINI SERIE MG.TX  
MINI T-STÜCK SERIE MG.TX

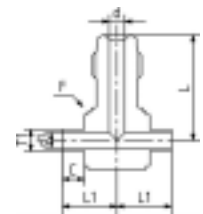

T1 Tube O.D.	T Tube O.D.	Part Number	L		L1 mm	d1 mm	d mm	C		F mm	Workin Pressu	
			mm	INCH				mm	INCH		PSIG	BAR
<b>Fractional</b>												
1/4"	1/4"	MG.TX 14.M.14	31,0	1,22	15,9	4,6	4,6	6,4	0,25	17	5100	:
3/8"	1/4"	MG.TX 38.M.38	31,0	1,22	15,9	7,7	4,6	6,4	0,25	17	3300	:

TEE SERIE TX  
TE SERIE TX  
T-STÜCK SERIE TX

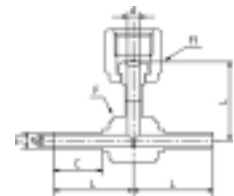

T1 Tube O.D.	T Tube O.D.	Part Number ①	L		d1 mm	d mm	C		F mm	F1 mm	Worl Pres PSIG
			mm	INCH			mm	INCH			
<b>Fractional</b>											
1/4"	1/4"	TX 14W.F.14W	31,0	1,22	4,6	4,6	19,1	0,75	17	19,1	5100
3/8"	1/4"	TX 38W.F.38W	31,0	1,22	7,7	4,6	19,1	0,75	17	19,1	3300

MINI TEE SERIE MG.TX  
TE MINI SERIE MG.TX  
MINI T-STÜCK SERIE MG.TX

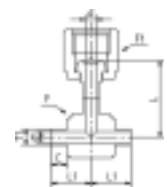

T1 Tube O.D.	T Tube O.D.	Part Number	L		L1 mm	d1 mm	d mm	C		F mm	F1 mm	W Pr PSI
			mm	INCH				mm	INCH			
<b>Fractional</b>												
1/4"	1/4"	MG.TX 14.F.14	31,0	1,22	15,9	4,6	4,6	6,4	0,25	17	19,1	5100
3/8"	1/4"	MG.TX 38.F.38	31,0	1,22	15,9	7,7	4,6	6,4	0,25	17	19,1	3300

① On request: it can be delivered with shoulder (Example: TX 14.M.14)

# GAZEL® Space Savers Fittings

## TEES

## TES

## T-STÜCKE

TEE SERIE TX  
TE SERIE TX  
T-STÜCK SERIE TX

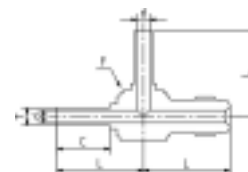

T Tube O.D.	Part Number	L		C		d	F	Working Pressure	
		mm	INCH	mm	INCH	mm	mm	PSIG	BAR
<b>Fractional</b>									
1/4"	TX 214W.M ①	31,0	1,22	19,1	0,75	4,6	17	5100	350

MINI TEE SERIE MG.TX  
TE MINI SERIE MG.TX  
MINI T-STÜCK SERIE MG.TX

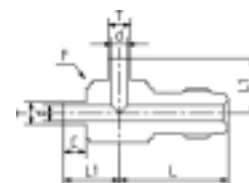
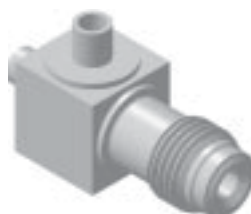

T Tube O.D.	Part Number	L		L1	d	C		F	Working Pressure	
		mm	INCH	mm	mm	mm	INCH	mm	PSIG	BAR
<b>Fractional</b>										
1/4"	MG.TX 214 M	31,0	1,22	15,9	4,6	6,4	0,25	17	5100	350

TEE SERIE TX  
TE SERIE TX  
T-STÜCK SERIE TX

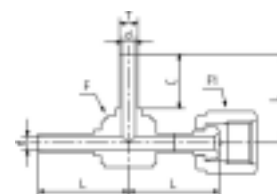

T Tube O.D.	Part Number	L		d	C		F	F1	Working Pressure	
		mm	INCH	mm	mm	INCH	mm	mm	PSIG	BAR
<b>Fractional</b>										
1/4"	TX 214W.F ①	31,0	1,22	4,6	19,1	0,75	17	19,1	5100	350

MINI TEE SERIE MG.TX  
TE MINI SERIE MG.TX  
MINI T-STÜCK SERIE MG.TX

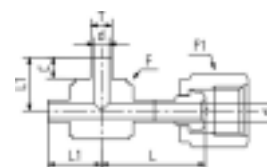

T Tube O.D.	Part Number	L		L1	d	C		F	F1	Working Pressure
		mm	INCH	mm	mm	mm	INCH	mm	mm	PSIG
<b>Fractional</b>										
1/4"	MG.TX 214.F	31,0	1,22	15,9	4,6	6,4	0,25	17	19,1	5100

① On request: it can be delivered with shoulder (Example: TX 214.M)

# GAZEL® Space Savers Fittings

## TEES

## TES

## T-STÜCKE

TEE SERIE TX  
TE SERIE TX  
T-STÜCK SERIE TX

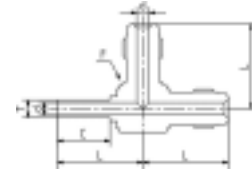

T Tube O.D.	Part Number	L		d	C		F	Working Pressure		
		mm	INCH	mm	mm	INCH	mm	PSIG	BAR	
<b>Fractional</b>										
1/4"	TX 14W.2M ①	31,0	1,22	4,6	19,1	0,75	17	5100	350	

MINI TEE SERIE MG.TX  
TE MINI SERIE MG.TX  
MINI T-STÜCK SERIE MG.TX

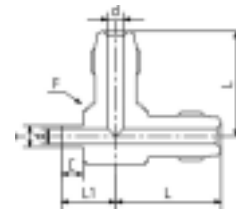

T Tube O.D.	Part Number	L		L1	d	C		F1	Working Pressure	
		mm	INCH	mm	mm	mm	INCH	mm	PSIG	BAR
<b>Fractional</b>										
1/4"	MG.TX 14.2M	31,0	1,22	15,9	4,6	6,4	0,25	17	5100	350

TEE SERIE TX  
TE SERIE TX  
T-STÜCK SERIE TX

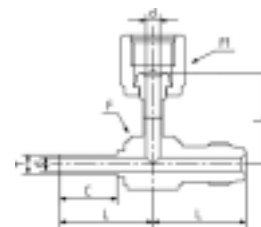

T Tube O.D.	Part Number	L		d	C		F	F1	Working Pressure	
		mm	INCH	mm	mm	INCH	mm	mm	PSIG	BAR
<b>Fractional</b>										
1/4"	TX 14W.FM ①	31,0	1,22	4,6	19,1	0,75	17	19,1	5100	350

MINI TEE SERIE MG.TX  
TE MINI SERIE MG.TX  
MINI T-STÜCK SERIE MG.TX

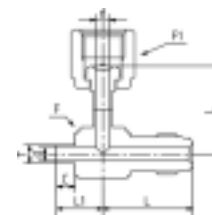

T Tube O.D.	Part Number	L		L1	d	C		F	F1	F
		mm	INCH	mm	mm	mm	INCH	mm	mm	PS
<b>Fractional</b>										
1/4"	MG.TX 14.FM	31,0	1,22	15,9	4,6	6,4	0,25	17	19,1	51

① On request it can be delivered with shoulder (Example: TX 14.2M).

# GAZEL® Space Savers Fittings

## TEES

## TES

## T-STÜCKE

TEE SERIE TX  
TE SERIE TX  
T-STÜCK SERIE TX

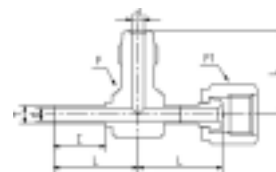

T Tube O.D.	Part Number	L		d	C		F	F1	Workin Pressu	
		mm	INCH	mm	mm	INCH	mm	mm	PSIG	BAR
<b>Fractional</b>										
1/4"	TX 14W.MF ①	31,0	1,22	4,6	19,1	0,75	17	19,1	5100	

MINI TEE SERIE MG.TX  
TE MINI SERIE MG.TX  
MINI T-STÜCK SERIES MG.TX

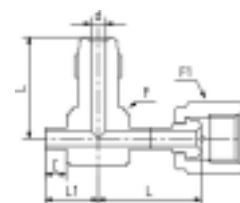

T Tube O.D.	Part Number	L		L1	d	C		F	F1	F
		mm	INCH	mm	mm	mm	INCH	mm	mm	PS
<b>Fractional</b>										
1/4"	MG.TX 14.MF	31,0	1,22	15,9	4,6	6,4	0,25	17	19,1	5100

TEE SERIE TX  
TE SERIE TX  
T-STÜCK SERIE TX

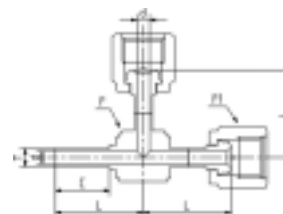

T Tube O.D.	Part Number	L		d	C		F	F1	Workin Press	
		mm	INCH	mm	mm	INCH	mm	mm	PSIG	BAR
<b>Fractional</b>										
1/4"	TX 14W.2F ①	31,0	1,22	4,6	19,1	0,75	17	19,1	5100	

MINI TEE SERIE MG.TX  
TE MINI SERIE MG.TX  
MINI T-STÜCK SERIE MG.TX

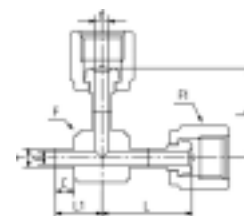

T Tube O.D.	Part Number	L		L1	d	C		F	F1	F
		mm	INCH	mm	mm	mm	INCH	mm	mm	PS
<b>Fractional</b>										
1/4"	MG.TX 14.2F	31,0	1,22	15,9	4,6	6,4	0,25	17	19,1	5100

① On request it can be delivered with shoulder (Example: TX 14.MF).

# GAZEL® Space Savers Fittings

## TEES

## TES

## T-STÜCKE

TEE SERIE TX  
TE SERIE TX  
T-STÜCK SERIE TX

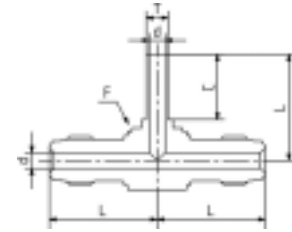

T Tube O.D.	Part Number	L		d	C		F	Working Pressure	
		mm	INCH	mm	mm	INCH	mm	PSIG	BAR
<b>Fractional</b>									
1/4"	TX M.14W.M ①	31,0	1,22	4,6	19,1	0,75	17	5100	350

MINI TEE SERIE MG.TX  
TE MINI SERIE MG.TX  
MINI T-STÜCK SERIE MG.TX

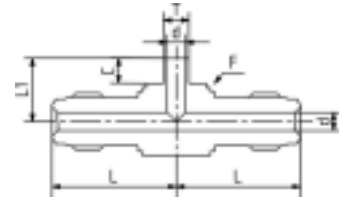
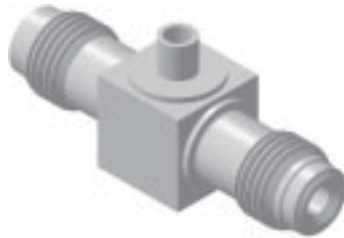

T Tube O.D.	Part Number	L		L1	d	C		F	Workin Pressu	
		mm	INCH	mm	mm	mm	INCH	mm	PSIG	BAR
<b>Fractional</b>										
1/4"	MG.TX M.14.M	31,0	1,22	15,9	4,6	6,4	0,25	17	5100	

TEE SERIE TX  
TE SERIE TX  
T-STÜCK SERIE TX

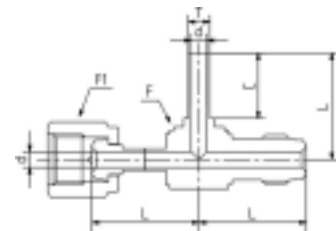
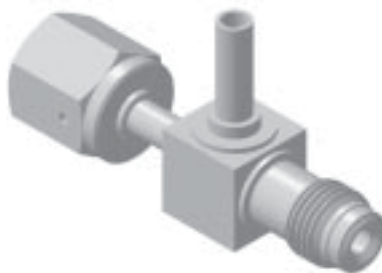

T Tube O.D.	Part Number	L		d	C		F	F1	Work Press	
		mm	INCH	mm	mm	INCH	mm	mm	PSIG	BAR
<b>Fractional</b>										
1/4"	TX F.14W.M ①	31,0	1,22	4,6	19,1	0,75	17	19,1	5100	

① On request it can be delivered with shoulder (Example: TX M.14.M).



# GAZEL® Space Savers Fittings

## TEES

## TES

## T-STÜCKE

MINI TEE SERIE MG.TX  
TE MINI SERIE MG.TX  
MINI T-STÜCK SERIE MG.TX

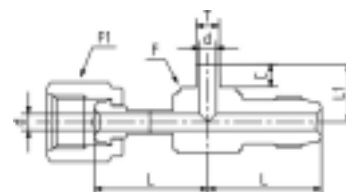

T Tube O.D.	Part Number	L		L1	d	C		F	F1	PSI
		mm	INCH	mm	mm	mm	INCH	mm	mm	
<b>Fractional</b>										
1/4"	MG.TX F.14.M	31,0	1,22	15,9	4,6	6,4	0,25	17	19,1	51

MINI TEE SERIE TX  
TE MINI SERIE TX  
MINI T-STÜCK SERIE TX

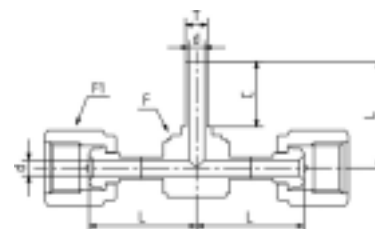
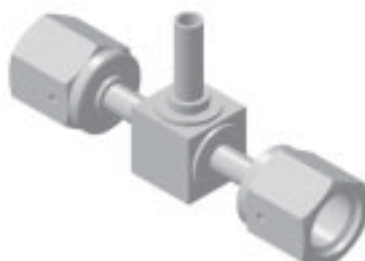

T Tube O.D.	Part Number	L		d	C		F	F1	Worki Presst	
		mm	INCH	mm	mm	INCH	mm	mm	PSIG	
<b>Fractional</b>										
1/4"	TX F.14W.F ①	31,0	1,22	4,6	19,1	0,75	17	19,1	5100	

MINI TEE SERIES MG.TX  
TE MINI SERIE MG.TX  
MINI T-STÜCK SERIE MG.TX

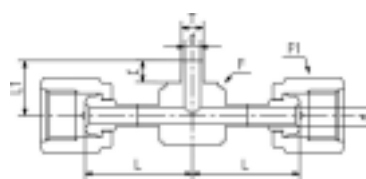
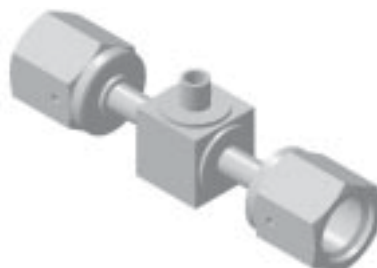

T Tube O.D.	Part Number	L		L1	d	C		F	F1	PSI
		mm	INCH	mm	mm	mm	INCH	mm	mm	
<b>Fractional</b>										
1/4"	MG.TX F.14.F	31,0	1,22	15,9	4,6	6,4	0,25	17	19,1	51

① On request it can be delivered with shoulder (Example: TX F.14.F)

# GAZEL® Space Savers Fittings

## CROSSES

## CROIX

## KREUZSTÜCKE

CROSS SERIE CD  
CROIX SERIE CD  
KREUZSTÜCK SERIE CD

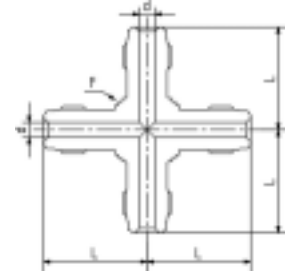

T Tube O.D.	Part Number	L		d		F	Working Pressure		
		mm	INCH	mm	INCH	mm	PSIG	BAR	
<b>Fractional</b>									
1/4"	CD 14 4M	31,0	1,22	4,6	0,18	17	8000	550	

CROSS SERIE CD  
CROIX SERIE CD  
KREUZSTÜCK SERIE CD

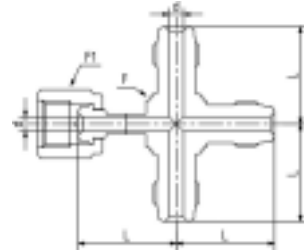

T Tube O.D.	Part Number	L		d		F	F1	Working Pressure	
		mm	INCH	mm	INCH	mm	mm	PSIG	BAR
<b>Fractional</b>									
1/4"	CD 14 F.3M	31,0	1,22	4,6	0,18	17	19,1	5100	350

CROSS SERIE CD  
CROIX SERIE CD  
KREUZSTÜCK SERIE CD

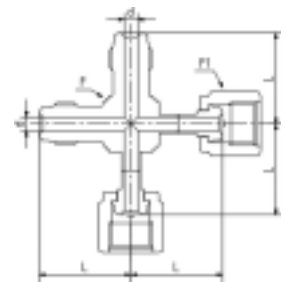

T Tube O.D.	Part Number	L		d		F	F1	Working Pressure	
		mm	INCH	mm	INCH	mm	mm	PSIG	BAR
<b>Fractional</b>									
1/4"	CD 14 2M.2F	31,0	1,22	4,6	0,18	17	19,1	5100	350

# GAZEL® Space Savers Fittings

## CROSSES

## CROIX

## KREUZSTÜCKE

CROSS SERIE CD  
CROIX SERIE CD  
KREUZSTÜCK CD

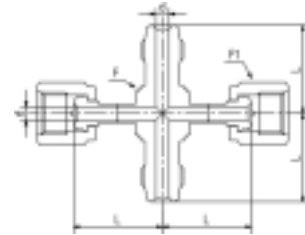

T Tube O.D.	Part Number	L		d		F	F1	Working Pressure	
		mm	INCH	mm	INCH			PSIG	BAR
<b>Fractional</b>									
1/4"	CD 14 FMFM	31,0	1,22	4,6	0,18	17	19,1	5100	350

CROSS SERIE CD  
CROIX SERIE CD  
KREUZSTÜCK SERIE CD

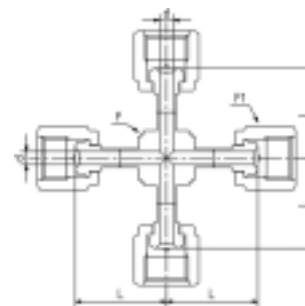

T Tube O.D.	Part Number	L		d		F	F1	Working Pressure	
		mm	INCH	mm	INCH			PSIG	BAR
<b>Fractional</b>									
1/4"	CD 14 4F	31,0	1,22	4,6	0,18	17	19,1	5100	350

# GAZEL® Space Savers Fittings

## CROSSES

## CROIX

## KREUZSTÜCKE

CROSS SERIE CX  
CROIX SERIE CX  
KREUZSTÜCK SERIE CX

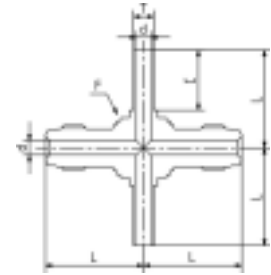

T Tube O.D.	Part Number	L		d	C		F	Workir Pressu		
		mm	INCH	mm	mm	INCH	mm	PSIG	t	
<b>Fractional</b>										
1/4"	CX M.14W.M.14W ①	31,0	1,22	4,6	19,1	0,75	17	5100		

MINI CROSS SERIE MG.CX  
CROIX MINI SERIE MG.CX  
MINI KREUZSTÜCK SERIE MG.CX

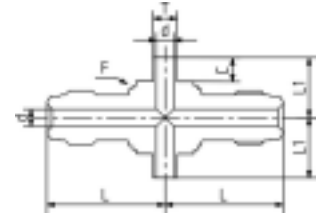

T Tube O.D.	Part Number	L		L1	d	C		F	Wor Pres	
		mm	INCH	mm	mm	mm	INCH	mm	PSIG	
<b>Fractional</b>										
1/4"	MG.CX M.14.M.14	31,0	1,22	15,9	4,6	6,4	0,25	17	5100	

CROSS SERIE CX  
CROIX SERIE CX  
KREUZSTÜCK SERIE CX

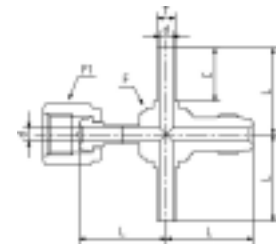

T Tube O.D.	Part Number	L		d	C		F	F1		
		mm	INCH	mm	mm	INCH	mm	mm	PS	
<b>Fractional</b>										
1/4"	CX F.14W.M.14W ①	31,0	1,22	4,6	19,1	0,75	17	19,1	51	

① On request it can be delivered with shoulder (Example: CX M.14.M.14)

# GAZEL® Space Savers Fittings

## CROSSES

## CROIX

## KREUZSTÜCKE

MINI CROSS SERIE MG.CX  
CROIX MINI SERIES MG.CX  
MINI KREUZSTÜCK SERIE MG.CX

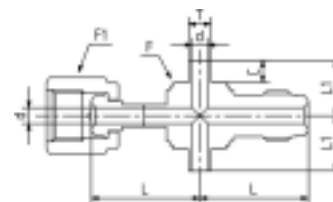

T Tube O.D.	Part Number	L		L1	d	C		F	F1
		mm	INCH	mm	mm	mm	INCH	mm	mm
<b>Fractional</b>									
1/4"	MG.CX F.14.M.14	31,0	1,22	15,9	4,6	6,4	0,25	17	19,1

CROSS SERIE CX  
CROIX SERIE CX  
KREUZSTÜCK SERIE CX

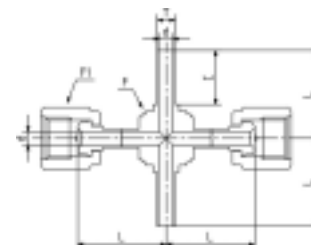

T Tube O.D.	Part Number	L		d	C		F	F1	V F
		mm	INCH	mm	mm	INCH	mm	mm	PS
<b>Fractional</b>									
1/4"	CXF.14W.F.14W ①	31,0	1,22	4,6	19,1	0,75	17	19,1	510

MINI CROSS SERIE MG.CX  
CROIX MINI SERIES MG.CX  
MINI KREUZSTÜCK SERIE MG.CX

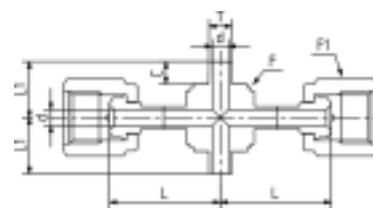
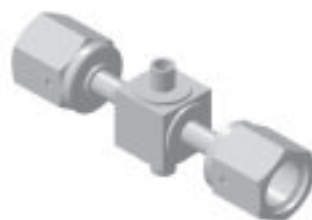

T Tube O.D.	Part Number	L		L1	d	C		F	F1
		mm	INCH	mm	mm	mm	INCH	mm	mm
<b>Fractional</b>									
1/4"	MG.CX F.14.F.14	31,0	1,22	15,9	4,6	6,4	0,25	17	19,1

① On request it can be delivered with shoulder (Example: CX F.14.F.14)

# GAZEL® High Flow Fittings

## NUTS

## ECROUS

## DRUCKSCHRAUBEN/MUTTERN

**FEMALE NUT FOR HIGH FLOW APPLICATIONS**  
**ECROU FEMELLE POUR LES APPLICATIONS DE DEBITS IMPORTANTS**  
**MUTTER FÜR ANWENDUNGEN MIT HOHEM DURCHFLUSS**

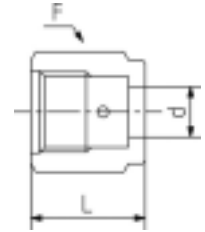

Tube O.D.	Part Number	L		d		Thread Size	F
		mm	INCH	mm	INCH		
3/8"	FN 14 HF	20,6	0,81	9,9	0,39	9/16"-18	19

**MALE NUT FOR HIGH FLOW APPLICATIONS**  
**ECROU MALE POUR LES APPLICATIONS DE DEBITS IMPORTANTS**  
**DRUCKSCHRAUBE FÜR ANWENDUNGEN MIT HOHEM DURCHFLUSS**

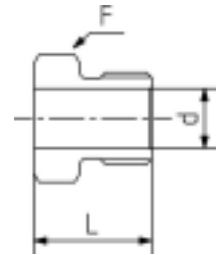

Tube O.D.	Part Number	L		d		Thread Size	F
		mm	INCH	mm	INCH		
3/8"	MN 14 HF	18,3	0,72	9,9	0,39	9/16"-18	17

## GLANDS

## EMBOUS

## STUTZEN

**SHORT MALE GLAND FOR HIGH FLOW APPLICATIONS**  
**EMBOUT MALE COURT POUR LES APPLICATIONS DE DEBITS IMPORTANTS**  
**MINI KURZSTUTZEN FÜR ANWENDUNGEN MIT HOHEM DURCHFLUSS**

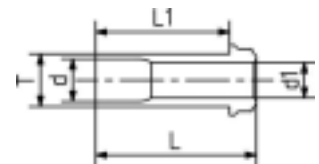

T Tube O.D.	Part Number	L		L1		d1		d		No T mi
		mm	INCH	mm	INCH	mm	INCH	mm	INCH	
<b>Fractional</b>										
3/8"	EMC 14 38 HF	15,2	0,60	10,4	0,41	6,4	0,25	7,7	0,30	0,8
3/8"	EMS 14 38 HF	30,2	1,19	25,4	1,00	6,4	0,25	7,7	0,30	0,8
3/8"	EM 14 38 HF	33,3	1,31	28,4	1,12	6,4	0,25	7,7	0,30	0,8

# GAZEL® High Flow Fittings

## GLANDS

## EMBOUS

## STUTZEN

**AUTOMATIC BUTTWELD BODY FOR HIGH FLOW APPLICATIONS**  
**EMBOUT MALE A SOUDER POUR LES APPLICATIONS DE DEBITS IMPORTANTS**  
**STUMPSCHWEISSVERBINDUNG FÜR AUTOMATISCHES SCHWEISSEN FÜR ANWENDUNGEN MIT HOHEM DURCHFLUSS**

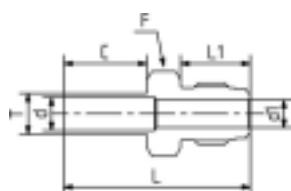

T Tube O.D.	Part Number	L		L1	d1		d		C		F	Working Pressure	
		mm	INCH	mm	mm	INCH	mm	INCH	mm	INCH	mm	PSIG	BAR
<b>fractional</b>													
3/8"	UM 14 38 ABW HF	42,7	1,68	15,7	6,4	0,25	7,7	0,30	19,1	0,75	15,7	3300	220

**AUTOMATIC BUTTWELD BODY FOR HIGH FLOW APPLICATIONS**  
**EMBOUT MALE A SOUDER POUR LES APPLICATIONS DE DEBITS IMPORTANTS**  
**STUMPSCHWEISSVERBINDUNG FÜR AUTOMATISCHES SCHWEISSEN FÜR ANWENDUNGEN MIT HOHEM DURCHFLUSS**

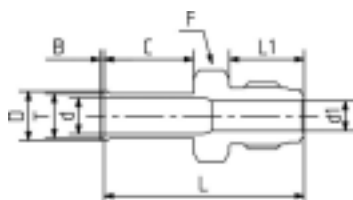

T Tube O.D.	Part Number	L		L1	d1		d		D	B	C		F	Working Pressure	
		mm	INCH	mm	mm	INCH	mm	INCH	mm	mm	mm	INCH	mm	PSIG	BAR
<b>fractional</b>															
3/8"	UM 14 38 AB HF	43,4	1,71	15,7	6,4	0,25	7,7	0,30	10,5	0,8	19,1	0,75	15,7	3300	220

## BULKHEAD UNIONS

## TRAVERSEE DE CLOISON

## SCHOTTEINSCHRAUBVERBINDUNG

**BUTTWELD BULKHEAD UNION FOR HIGH FLOW APPLICATIONS**  
**TRAVERSEE DE CLOISON POUR SOUDURE AUTOMATIQUE BOUT A BOUT POUR LES APPLICATIONS DE DEBITS IMPORTANTS**  
**SCHOTTEINSCHRAUBVERBINDUNG FÜR ANWENDUNGEN MIT HOHEM DURCHFLUSS, MIT SCHWEISSSTUTZEN**

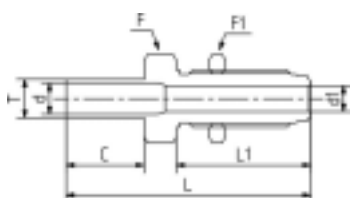

T Tube O.D.	Part Number	L		L1	d1		d		C	F	F1	Panel Hole Size	Max Panel Thickness	Working Pressure		
		mm	INCH	mm	mm	INCH	mm	INCH	mm	INCH	mm	mm	mm	PSIG	BAR	
<b>fractional</b>																
3/8"	BU 14 38 HF	59,9	2,36	33,0	6,4	0,25	7,7	0,30	19,1	0,75	19,1	19,1	15,1	11,2	3300	220

# GAZEL® High Flow Fittings

## ELBOWS & TEES

## COUDES ET TES

## WINKEL & T-STÜCKE

### ELBOW FOR HIGH FLOW APPLICATIONS

COUDE POUR LES APPLICATIONS DE DEBITS IMPORTANTS

WINKELSTÜCK, FÜR ANWENDUNGEN MIT HOHEM DURCHFLUSS

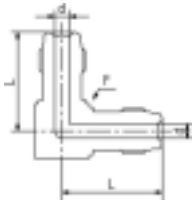

T Tube O.D.	Part Number	L		d		F	Working Pressure	
		mm	INCH	mm	INCH	mm	PSIG	BAR
<b>Fractional</b>								
1/4"	E 14 HF	27,2	1,07	6,4	0,25	17	8000	550

### TEE FOR HIGH FLOW APPLICATIONS

TE POUR LES APPLICATIONS DE DEBITS IMPORTANTS

EINSCHRAUB T-STÜCK FÜR ANWENDUNGEN MIT HOHEM DURCHFLUSS

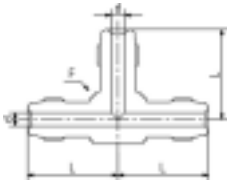

T Tube O.D.	Part Number	L		d		F	Working Pressure	
		mm	INCH	mm	INCH	mm	PSIG	BAR
<b>Fractional</b>								
1/4"	T 14 HF	27,2	1,07	6,4	0,25	17	8000	550



# GAZEL® Micro Fittings

## REDUCER

## REDUCTION

## REDUZIERSTUTZEN

MINI REDUCING UNION WITHOUT SHOULDER  
 UNION REDUCTION MINI SANS COLLERETTE  
 MINI GERADER REDUZIERSTUTZEN OHNE WULST

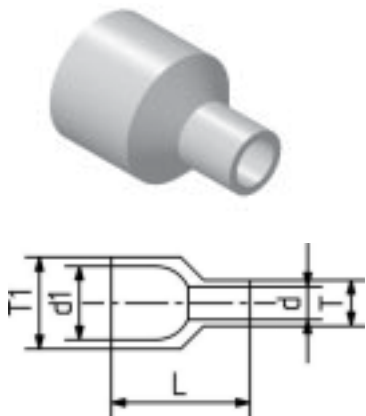

T1 Tube O.D.	T Tube O.D.	Part Number ②	L		d1 mm	d mm	Working Pressure	
			mm	INCH			PSIG	BAR
<b>Fractional</b>								
1/4"	1/8"	MG.RU 14 18 ①	19,1	0,75	4,6	1,5	5100	350
3/8"	1/4"	MG.RU 38 14	19,1	0,75	7,7	4,6	3300	220
1/2"	1/4"	MG.RU 12 14	19,1	0,75	10,2	4,6	3500	240
1/2"	3/8"	MG.RU 12 38	19,1	0,75	10,2	7,7	3300	220
<b>Jis</b>								
3/8"	1/4"	MG.RU 38J 14J	19,1	0,75	7,5	4,4	3500	240
1/2"	1/4"	MG.RU 12 14J	19,1	0,75	10,2	4,4	3500	240
1/2"	3/8"	MG.RU 12 38J	19,1	0,75	10,2	7,5	3500	240

## ELBOWS

## COUDES

## WINKEL

MINI ELBOW WITHOUT SHOULDER  
 COUDE MINI SANS COLLERETTE  
 MINI WINKEL-SCHEISSSTÜCK OHNE WULST

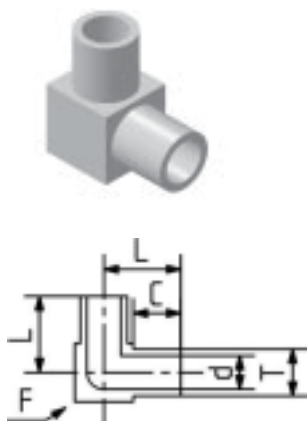

T Tube O.D.	Part Number	L		d		C		F mm	Working Pressure	
		mm	INCH	mm	INCH	mm	INCH		PSIG	BAR
<b>Fractional</b>										
1/8"	MG.E 18	10,4	0,41	1,5	0,06	6,4	0,25	7,9	5100	350
1/4"	MG.E 14	10,4	0,41	4,6	0,18	6,4	0,25	7,9	5100	350
3/8"	MG.E 38	11,9	0,47	7,7	0,30	6,4	0,25	11,1	3300	220
1/2"	MG.E 12	13,5	0,53	10,2	0,40	6,4	0,25	14,3	3500	240
<b>Metric</b>										
6mm	MG.E 6M	10,4	0,41	4,0	0,16	6,4	0,25	7,9	6800	460
10mm	MG.E 10M	11,9	0,47	8,0	0,31	6,4	0,25	11,1	3500	240
12mm	MG.E 12M	13,5	0,53	10,0	0,39	6,4	0,25	14,3	3100	210
<b>Jis</b>										
1/4"	MG.E 14J	10,4	0,41	4,4	0,17	6,4	0,25	7,9	5600	380
3/8"	MG.E 38J	11,9	0,47	7,5	0,29	6,4	0,25	11,1	3500	240

MINI ELBOW WITH SHOULDERS  
 COUDE MINI AVEC COLLERETTES  
 MINI WINKEL SCHWEISSSTÜCK MIT WULST

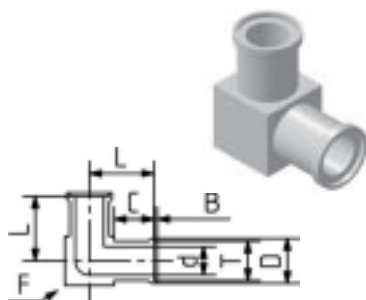

T Tube O.D.	Part Number	L		d		D	B	C	F	Working Pressure			
		mm	INCH	mm	INCH					mm	INCH	PSIG	BAR
<b>Fractional</b>													
1/8"	MG.FE 18	10,4	0,41	1,5	0,06	3,8	0,15	0,5	6,4	0,25	7,9	5100	350
1/4"	MG.FE 14	10,4	0,41	4,6	0,18	7,4	0,29	0,5	6,4	0,25	7,9	5100	350
3/8"	MG.FE 38	11,9	0,47	7,7	0,30	10,5	0,41	0,8	6,4	0,25	11,1	3300	220

① On request it can be delivered with shoulder (Example: MG.FRU 14 18).

② On request it can be delivered in metric (Example: MG.RU 8M 6M)

# GAZEL® Micro Fittings

## ELBOWS

## COUDES

## WINKEL

MINI ELBOW WITHOUT SHOULDER  
 COUDE MINI SANS COLLERETTE  
 MINI WINKEL SCHWEISSSTÜCK OHNE WULST

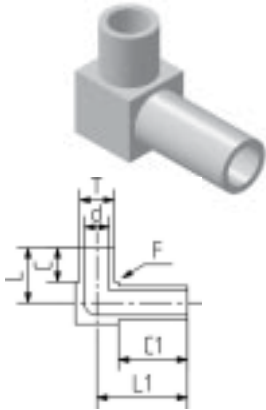

T Tube O.D.	Part Number	L		L1		d		C		C1		F		Working Pressure	
		mm	INCH	mm	INCH	mm	INCH	mm	INCH	mm	INCH	mm	PSIG	BAR	
<b>Fractional</b>															
1/4"	MG.EL 14.2	10,4	0,41	15,5	0,61	4,6	0,18	6,4	0,25	11,4	0,45	7,9	5100	350	
1/4"	MG.EL 14.3	10,4	0,41	16,8	0,66	4,6	0,18	6,4	0,25	12,7	0,50	7,9	5100	350	
1/4"	MG.EL 14.4	15,5	0,61	15,5	0,61	4,6	0,18	11,4	0,45	11,4	0,45	7,9	5100	350	
1/4"	MG.EL 14.5	16,8	0,66	16,8	0,66	4,6	0,18	12,7	0,50	12,7	0,50	7,9	5100	350	
<b>Jis</b>															
1/4"	MG.EL 14J.2	10,4	0,41	15,5	0,61	4,4	0,17	6,4	0,25	11,4	0,45	7,9	5600	380	
1/4"	MG.EL 14J.3	10,4	0,41	16,8	0,66	4,4	0,17	6,4	0,25	12,7	0,50	7,9	5600	380	
1/4"	MG.EL 14J.4	15,5	0,61	15,5	0,61	4,4	0,17	11,4	0,45	11,4	0,45	7,9	5600	380	
1/4"	MG.EL 14J.5	16,8	0,66	16,8	0,66	4,4	0,17	12,7	0,50	12,7	0,50	7,9	5600	380	

MINI ELBOW 45° WITHOUT SHOULDER  
 COUDE MINI 45° SANS COLLERETTE  
 MINI WINKEL SCHWEISSSTÜCK 45° OHNE WULST

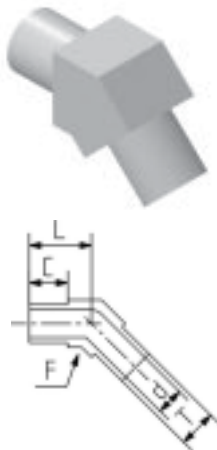

T Tube O.D.	Part Number	L		d		C		F		Working Pressure	
		mm	INCH	mm	INCH	mm	INCH	mm	PSIG	BAR	
<b>Fractional</b>											
1/4"	MG.E5 14	10,4	0,41	4,6	0,18	6,4	0,25	7,9	5100	350	
3/8"	MG.E5 38	11,9	0,47	7,7	0,30	6,4	0,25	11,1	3300	220	
1/2"	MG.E5 12	13,5	0,53	10,2	0,40	6,4	0,25	14,3	3500	240	
<b>Jis</b>											
1/4"	MG.E5 14J	10,4	0,41	4,4	0,17	6,4	0,25	7,9	5600	380	
3/8"	MG.E5 38J	11,9	0,47	7,5	0,29	6,4	0,25	11,1	3500	240	

# GAZEL® Micro Fittings

## ELBOWS

## COUDES

## WINKEL

### MINI REDUCING ELBOW WITHOUT SHOULDER COUDE REDUCTION MINI SANS COLLERETTE MINI REDUZIER SCHWEISSSTÜCK OHNE WULST

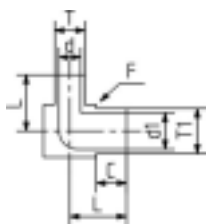

T1 Tube O.D.	T Tube O.D.	Part Number	L		C		d1	d	F	Working Pressure	
			mm	INCH	mm	INCH	mm	mm	mm	PSIG	BAR
<b>Fractional</b>											
3/8"	1/4"	MG.RE 38 14	11,9	0,47	6,4	0,25	7,7	4,6	11,1	3300	220
1/2"	1/4"	MG.RE 12 14	13,5	0,53	6,4	0,25	10,2	4,6	14,3	3500	240
1/2"	3/8"	MG.RE 12 38	13,5	0,53	6,4	0,25	10,2	7,7	14,3	3300	220
<b>Metric</b>											
10mm	6mm	MG.RE 10M 6M	11,9	0,47	6,4	0,25	8,0	4,0	11,1	3500	240
12mm	6mm	MG.RE 12M 6M	13,5	0,53	6,4	0,25	10,0	4,0	14,3	3100	210
<b>Jis</b>											
3/8"	1/4"	MG.RE 38J 14J	11,9	0,47	6,4	0,25	7,5	4,4	11,1	3500	240
1/2"	1/4"	MG.RE 12 14J	13,5	0,53	6,4	0,25	10,2	4,4	14,3	3500	240
1/2"	3/8"	MG.RE 12 38J	13,5	0,53	6,4	0,25	10,2	7,5	14,3	3500	240

### MINI 3-DIMENSIONAL ELBOW WITHOUT SHOULDER COUDE TRIDIMENSIONEL SANS COLLERETTE MINI 3-DIMENSIONALER WINKEL OHNE WULST

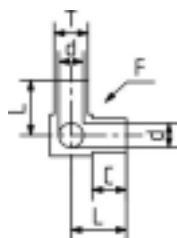

T Tube O.D.	Part Number	L		d		C		F	Working Pressure	
		mm	INCH	mm	INCH	mm	INCH	mm	PSIG	BAR
<b>Fractional</b>										
1/4"	14/MG.E 14	10,4	0,41	4,6	0,18	6,4	0,25	7,9	5100	350
3/8"	38/MG.E 38	11,9	0,47	7,7	0,30	6,4	0,25	11,1	3300	220
1/2"	12/MG.E 12	13,5	0,53	10,2	0,40	6,4	0,25	14,3	3500	240
<b>Jis</b>										
1/4"	14J/MG.E 14J	10,4	0,41	4,4	0,17	6,4	0,25	7,9	5600	380
3/8"	38J/MG.E 38J	13,5	0,53	7,5	0,30	6,4	0,25	11,1	3500	240

# GAZEL® Micro Fittings

## TEES

## TES

## T-STÜCKE

MINI TEE WITHOUT SHOULDER  
TE MINI SANS COLLERETTE  
MINI T-SCHWEISSSTÜCK OHNE WULST

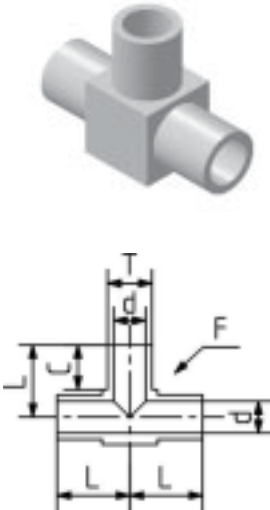

T Tube O.D.	Part Number	L		d		C		F	Working Pressure	
		mm	INCH	mm	INCH	mm	INCH		mm	PSIG
<b>Fractional</b>										
1/8"	MG.T 18	10,4	0,41	1,5	0,06	6,4	0,25	7,9	5100	350
1/4"	MG.T 14 ①	10,4	0,41	4,6	0,18	6,4	0,25	7,9	5100	350
3/8"	MG.T 38 ①	11,9	0,47	7,7	0,30	6,4	0,25	11,1	3300	220
1/2"	MG.T 12	13,5	0,53	10,2	0,40	6,4	0,25	14,3	3500	240
<b>Metric</b>										
6mm	MG.T 6M	10,3	0,41	4,0	0,16	6,4	0,25	7,9	6800	460
10mm	MG.T 10M	11,9	0,47	8,0	0,31	6,4	0,25	11,1	3500	240
12mm	MG.T 12M	13,5	0,53	10,0	0,39	6,4	0,25	14,3	3100	210
<b>Jis</b>										
1/4"	MG.T 14J	10,4	0,41	4,4	0,17	6,4	0,25	7,9	5600	380
3/8"	MG.T 38J	11,9	0,47	7,5	0,30	6,4	0,25	11,1	3300	220

MINI TEE WITH SHOULDERS  
TE MINI AVEC COLLERETTES  
MINI T-SCHWEISSSTÜCK MIT WULST

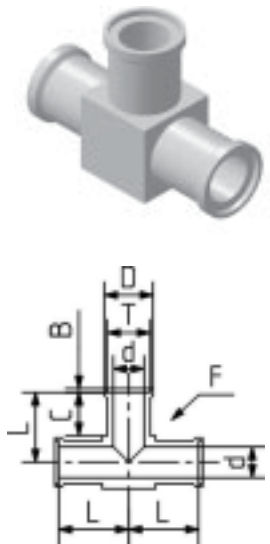

T Tube O.D.	Part Number	L		d		D	B	C		F	Working Pressure	
		mm	INCH	mm	INCH			mm	INCH		mm	PSIG
<b>Fractional</b>												
1/8"	MG.FT 18	10,4	0,41	1,5	0,06	3,8	0,5	6,4	0,25	7,9	5100	350
1/4"	MG.FT 14	10,4	0,41	4,6	0,18	7,4	0,5	6,4	0,25	7,9	5100	350
3/8"	MG.FT 38	11,9	0,47	7,7	0,30	10,5	0,8	6,4	0,25	11,1	3300	220

① On request in Alloy C-22 (HC22) material.

# GAZEL® Micro Fittings

## TEES

## TES

## T-STÜCKE

MINI TEE WITHOUT SHOULDER  
TE MINI SANS COLLERETTE  
MINI T-SCHWEISSSTÜCK OHNE WULST

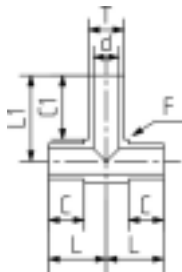

T Tube O.D.	Part Number	L		L1		d		C		C1		F	Working Pressure	
		mm	INCH	mm	INCH	mm	INCH	mm	INCH	mm	INCH		PSIG	BAR
<b>Fractional</b>														
1/4"	MG.TL 14.6	10,4	0,41	15,5	0,61	4,6	0,18	6,4	0,25	11,4	0,45	7,9	5100	350
<b>Jis</b>														
1/4"	MG.TL 14J.6	10,4	0,41	15,5	0,61	4,4	0,17	6,4	0,25	11,4	0,45	7,9	5600	380

MINI TEE WITHOUT SHOULDER  
TE MINI SANS COLLERETTE  
MINI T-SCHWEISSSTÜCK OHNE WULST

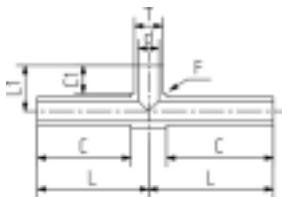

T Tube O.D.	Part Number	L		L1		d		C		C1		F	Working Pressure	
		mm	INCH	mm	INCH	mm	INCH	mm	INCH	mm	INCH		PSIG	BAR
<b>Fractional</b>														
1/4"	MG.TUL 14.1	24,9	0,98	10,4	0,41	4,6	0,18	21,1	0,83	6,4	0,25	7,9	5100	350
<b>Jis</b>														
1/4"	MG.TUL 14J.1	24,9	0,98	10,4	0,41	4,4	0,17	21,1	0,83	6,4	0,25	7,9	5600	380

# GAZEL® Micro Fittings

## TEES

## TES

## T-STÜCKE

MINI REDUCING TEE WITHOUT SHOULDER  
TE REDUCTION MINI SANS COLLERETTE  
MINI REDUZIER T-SCHWEISSSTÜCK OHNE WULST

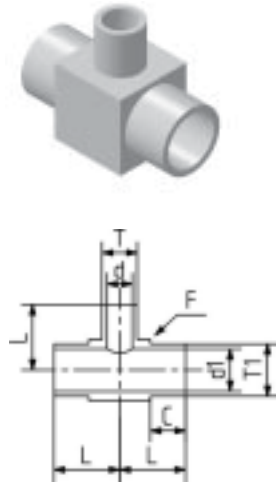

T1 Tube O.D.	T Tube O.D.	Part Number	L		d1		d		C		F		Working Pressure	
			mm	INCH	mm	mm	mm	INCH	mm	PSIG	BAR			
<b>Fractional</b>														
3/8"	1/4"	MG.RT 38 14	11,9	0,47	7,7	4,6	6,4	0,25	11,1	3300	220			
1/2"	1/4"	MG.RT 12 14	13,5	0,53	10,2	4,6	6,4	0,25	14,3	3500	240			
1/2"	3/8"	MG.RT 12 38	13,5	0,53	10,2	7,7	6,4	0,25	14,3	3300	220			
<b>Metric</b>														
10mm	6mm	MG.RT 10M 6M	11,9	0,47	8,0	4,0	6,4	0,25	11,1	3500	240			
12mm	6mm	MG.RT 12M 6M	13,5	0,53	10,0	4,0	6,4	0,25	14,3	3100	210			
<b>Jis</b>														
3/8"	1/4"	MG.RT 38J 14J	11,9	0,47	7,5	4,4	6,4	0,25	11,1	3500	240			
1/2"	1/4"	MG.RT 12 14J	13,5	0,53	10,2	4,4	6,4	0,25	14,3	3500	240			
1/2"	3/8"	MG.RT 12 38J	13,5	0,53	10,2	7,5	6,4	0,25	14,3	3500	240			

## CROSSES

## CROIX

## KREUZSTÜCKE

MINI CROSS WITHOUT SHOULDER  
CROUX MINI SANS COLLERETTE  
MINI KREUZSCHWEISSSTÜCK OHNE WULST

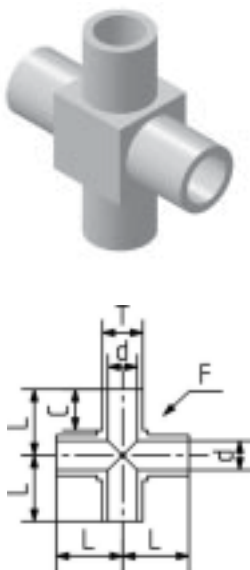

T Tube O.D.	Part Number	L		d		C		F		Working Pressure	
		mm	INCH	mm	INCH	mm	INCH	mm	PSIG	BAR	
<b>Fractional</b>											
1/8"	MG.C 18	10,4	0,41	1,5	0,06	6,4	0,25	7,9	5100	350	
1/4"	MG.C 14 ①	10,4	0,41	4,6	0,18	6,4	0,25	7,9	5100	350	
3/8"	MG.C 38 ①	11,9	0,47	7,7	0,30	6,4	0,25	11,1	3300	220	
1/2"	MG.C 12	13,5	0,53	10,2	0,40	6,4	0,25	14,3	3500	240	
<b>Metric</b>											
6mm	MG.C 6M	10,3	0,41	4,0	0,16	6,4	0,25	7,9	6800	460	
10mm	MG.C 10M	11,9	0,47	8,0	0,31	6,4	0,25	11,1	3500	240	
12mm	MG.C 12M	13,5	0,53	10,0	0,39	6,4	0,25	14,3	3100	210	
<b>Jis</b>											
1/4"	MG.C 14J	10,4	0,41	4,4	0,17	6,4	0,25	7,9	5600	380	
3/8"	MG.C 38J	11,9	0,47	7,5	0,29	6,4	0,25	11,1	3500	240	

① On request in Alloy C-22 (HC22) material.

# GAZEL® Weld Fittings

## UNIONS

## UNIONS

## SCHWEISSTUTZEN

**AUTOMATIC BUTTWELD SHORT UNION WITH SHOULDERS**  
**UNION AVEC COLLERETTES POUR SOUDURE AUTOMATIQUE BOUT A BOUT**  
**ZENTRIERWULST FÜR AUTOMATISCHES SCHWEISSEN MIT WULST**

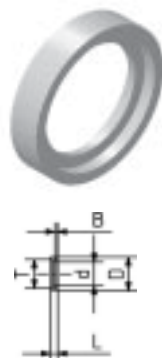

T Tube O.D.	Part Number	L		d		D	B	Working Pressure	
		mm	INCH	mm	INCH	mm	mm	PSIG	BAR
<b>Fractional</b>									
1/4"	US 14 AB	1,2	0,05	4,6	0,18	7,3	0,30	5100	350
3/8"	US 38 AB	1,6	0,06	7,7	0,30	10,4	0,50	3300	220
1/2"	US 12 AB	2,0	0,08	10,2	0,40	13,9	0,60	3500	240

**AUTOMATIC BUTTWELD REDUCING UNION WITHOUT SHOULDER**  
**UNION REDUCTION SANS COLLERETTE POUR SOUDURE AUTOMATIQUE BOUT A BOUT**  
**GERADER REDUZIER-SCHWEISSSTUTZEN OHNE WULST**



T1 Tube O.D.	T Tube O.D.	Part Number	L		d1	d	C		Working Pressure	
			mm	INCH	mm	mm	mm	INCH	PSIG	BAR
<b>Fractional</b>										
3/8"	1/4"	RU 38 14 ABW	38,1	1,50	7,7	4,6	19,1	0,75	3300	220
1/2"	1/4"	RU 12 14 ABW	38,1	1,50	10,2	4,6	19,1	0,75	3500	240
1/2"	3/8"	RU 12 38 ABW	38,1	1,50	10,2	7,7	19,1	0,75	3300	220
3/4"	1/2"	RU 34 12 ABW	38,1	1,50	16,5	10,2	19,1	0,75	2400	160
<b>Metric</b>										
8mm	6mm	RU 8M 6M ABW	38,1	1,50	6,0	4,0	19,1	0,75	4800	330
12mm	6mm	RU 12M 6M ABW	38,1	1,50	10,0	4,0	19,1	0,75	3100	210
12mm	8mm	RU 12M 8M ABW	38,1	1,50	10,0	6,0	19,1	0,75	3100	210
18mm	6mm	RU 18M 6M ABW	38,1	1,50	15,0	4,0	19,1	0,75	3100	210
18mm	12mm	RU 18M 12M ABW	38,1	1,50	15,0	10,0	19,1	0,75	3100	210
<b>Jis</b>										
3/8"	1/4"	RU 38J 14J ABW ①	38,1	1,50	7,5	4,4	19,1	0,75	3500	240
1/2"	1/4"	RU 12 14J ABW ①	38,1	1,50	10,2	4,4	19,1	0,75	3500	240
1/2"	3/8"	RU 12 38J ABW ①	38,1	1,50	10,2	7,5	19,1	0,75	3500	240

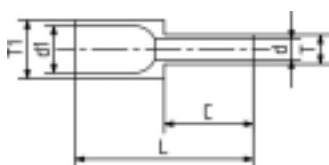

**AUTOMATIC BUTTWELD REDUCING UNION WITH SHOULDERS**  
**UNION REDUCTION AVEC COLLERETTES POUR SOUDURE AUTOMATIQUE BOUT A BOUT**  
**GERADER REDUZIER-SCHWEISSSTUTZEN, MIT WULST**



T1 Tube O.D.	T Tube O.D.	Part Number	L		d1	d	D1	D	B1	B	C		Working Pressure	
			mm	INCH	mm	mm	mm	mm	mm	mm	mm	INCH	PSIG	BAR
<b>Fractional</b>														
3/8"	1/4"	RU 38 14 AB	40,1	1,58	7,7	4,6	10,5	7,4	0,8	0,5	19,1	0,75	3300	220
1/2"	1/4"	RU 12 14 AB	40,1	1,58	10,2	7,7	14,0	7,4	1,0	0,5	19,1	0,75	3500	240
1/2"	3/8"	RU 12 38 AB	40,4	1,59	10,2	4,0	14,0	10,5	1,0	0,8	19,1	0,75	3300	220
3/4"	1/2"	RU 34 12 AB	40,6	1,60	16,5	10,2	20,3	14,0	1,0	1,0	19,1	0,75	2400	160
<b>Metric</b>														
8mm	6mm	RU 8M 6M AB	39,9	1,57	6,0	4,0	8,9	6,9	0,8	0,5	19,1	0,75	4800	330
12mm	6mm	RU 12M 6M AB	40,1	1,58	10,0	6,0	13,2	6,9	1,0	0,5	19,1	0,75	3100	210
12mm	8mm	RU 12M 8M AB	40,4	1,59	10,0	10,0	13,2	8,9	1,0	0,8	19,1	0,75	3100	210
<b>Jis</b>														
3/8"	1/4"	RU 38J 14J AB	40,1	1,58	7,5	4,4	10,3	7,2	0,8	0,5	19,1	0,75	3500	240
1/2"	1/4"	RU 12 14J AB	40,1	1,58	10,2	4,4	14,0	7,2	1,0	0,5	19,1	0,75	3500	240
1/2"	3/8"	RU 12 38J AB	40,4	1,59	10,2	7,5	14,0	10,3	1,0	0,8	19,1	0,75	3500	240

① On request, it can be delivered with C = 10mm (Example: RUS 38J 14J ABW)

# GAZEL® Weld Fittings

## ELBOWS

## COUDES

## WINKEL

**AUTOMATIC BUTTWELD ELBOW WITHOUT SHOULDER**  
**COUDE SANS COLLERETTE POUR SOUDURE AUTOMATIQUE BOUT A BOUT**  
**WINKEL-SCHWEISSTÜCK OHNE WULST**

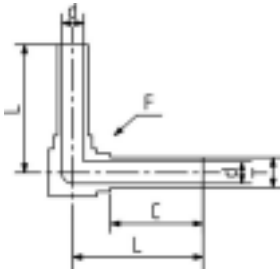

T Tube O.D.	Part Number	L		d		C		F	Working Pressure	
		mm	INCH	mm	INCH	mm	INCH		mm	PSIG
<b>Fractional</b>										
1/4"	E 14 ABW	27,0	1,06	4,6	0,18	19,1	0,75	10	5100	350
1/4"	ECA 14 ABW	31,2	1,23	4,6	0,18	19,1	0,75	10	5100	350
3/8"	E 38 ABW	27,0	1,06	7,7	0,30	19,1	0,75	14	3300	220
3/8"	ECA 38 ABW	30,5	1,20	7,7	0,30	19,1	0,75	14	3300	220
1/2"	E 12 ABW	30,0	1,18	10,2	0,40	19,1	0,75	17	3500	240
1/2"	ECA 12 ABW	34,0	1,34	10,2	0,40	19,1	0,75	17	3500	240
3/4"	E 34 ABW	35,0	1,38	16,5	0,65	19,1	0,75	24	2400	160
1"	E 100 ABW	40,0	1,57	22,1	0,87	24,4	0,96	35	2400	160
<b>Metric</b>										
6mm	E 6M ABW	27,0	1,06	4,0	0,16	19,1	0,75	10	6800	460
8mm	E 8M ABW	27,0	1,06	6,0	0,24	19,1	0,75	14	4800	330
10mm	E 10M ABW	27,0	1,06	8,0	0,31	19,1	0,75	14	3500	240
12mm	E 12 M ABW	30,0	1,18	10,0	0,39	19,1	0,75	17	3100	210
<b>Jis</b>										
1/4"	E 14J ABW ①	27,0	1,06	4,4	0,17	19,1	0,75	10	5600	380
3/8"	E 38J ABW ①	27,0	1,06	7,5	0,29	19,1	0,75	14	3500	240

**AUTOMATIC BUTTWELD REDUCING ELBOW WITHOUT SHOLDER**  
**COUDE REDUCTION SANS COLLERETTE POUR SOUDURE AUTOMATIQUE BOUT A BOUT**  
**WINKEL REDUZIER-SCHWEISSTÜCK OHNE WULST**

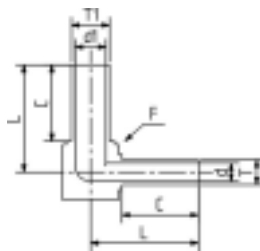

T1 Tube O.D.	T Tube O.D.	Part Number	L		d1		d		C		F	Working Pressure	
			mm	INCH	mm	INCH	mm	INCH	mm	INCH		mm	PSIG
<b>Fractional</b>													
3/8"	1/4"	RE 38 14 ABW	27,0	1,06	7,7	0,30	4,6	0,18	19,1	0,75	14	3300	220
1/2"	1/4"	RE 12 14 ABW	30,0	1,18	10,2	0,40	4,6	0,18	19,1	0,75	17	3500	240
1/2"	3/8"	RE 12 38 ABW	30,0	1,18	10,2	0,40	7,7	0,30	19,1	0,75	17	3300	220
<b>Jis</b>													
3/8"	1/4"	RE 38J 14J ABW	27,0	1,06	7,5	0,29	4,4	0,17	19,1	0,75	14	3500	240
1/2"	1/4"	RE 12 14J ABW	30,0	1,18	10,2	0,40	4,4	0,17	19,1	0,75	17	3500	240
1/2"	3/8"	RE 12 38J ABW	30,0	1,18	10,2	0,40	7,5	0,29	19,1	0,75	17	3500	240

① On request, it can be delivered with C = 10mm (Example: ES 14J ABW)



# GAZEL® Weld Fittings

## ELBOWS

## COUDES

## WINKEL

### AUTOMATIC BUTTWELD ELBOW WITH SHOULDERS

### COUDE AVEC COLLERETTES POUR SOUDURE AUTOMATIQUE BOUT A BOUT

### WINKEL-SCHWEISSTÜCK, MIT WULST

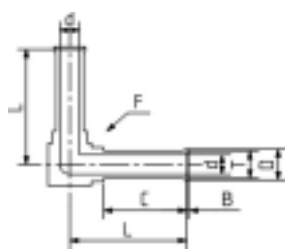

T Tube O.D.	Part Number	L		d		D	B	C		F	Working Pressure	
		mm	INCH	mm	INCH	mm	mm	mm	INCH	mm	PSIG	BAR
<b>Fractional</b>												
1/4"	E 14 AB	27,0	1,06	4,6	0,18	7,4	0,5	19,1	0,75	10	5100	350
1/4"	ECA 14 AB	31,7	1,25	4,6	0,18	7,4	0,5	19,1	0,75	10	5100	350
3/8"	E 38 AB	27,0	1,06	7,7	0,30	10,5	0,8	19,1	0,75	14	3300	220
3/8"	ECA 38 AB	31,2	1,23	7,7	0,30	10,5	0,8	19,1	0,75	14	3300	220
1/2"	E 12 AB	30,0	1,18	10,2	0,40	14,0	1,0	19,1	0,75	17	3500	240
1/2"	ECA 12 AB	35,0	1,38	10,2	0,40	14,0	1,0	19,1	0,75	17	3500	240
3/4"	E 34 AB	35,0	1,38	16,5	0,65	20,3	1,0	19,1	0,75	24	2400	160
1"	E 100 AB	40,0	1,57	22,1	0,87	26,9	1,0	24,4	0,96	35	2400	160
<b>Metric</b>												
6mm	E 6M AB	27,0	1,06	4,0	0,16	6,9	0,5	19,1	0,75	10	6800	460
6mm	ECA 6M AB	31,8	1,25	4,0	0,16	6,9	0,5	19,1	0,75	10	6800	460
8mm	E 8M AB	27,0	1,06	6,0	0,24	8,9	0,8	19,1	0,75	14	4800	330
8mm	ECA 8M AB	32,0	1,26	6,0	0,24	8,9	0,8	19,1	0,75	14	4800	330
10mm	E 10M AB	27,0	1,06	8,0	0,31	10,9	0,8	19,1	0,75	14	3500	240
10mm	ECA 10M AB	34,8	1,37	8,0	0,31	11,0	0,8	19,1	0,75	14	3500	240
12mm	E 12M AB	30,0	1,18	10,0	0,39	13,2	1,0	19,1	0,75	17	3100	210
12mm	ECA 12M AB	35,0	1,38	10,0	0,39	13,2	1,0	19,1	0,75	17	3100	210
18mm	ECA 18M AB	38,6	1,52	15,0	0,59	19,2	1,0	19,1	0,75	24	3000	200
<b>Jis</b>												
1/4"	E 14J AB	27,0	1,06	4,4	0,17	7,2	1,0	19,1	0,75	10	5600	380
3/8"	E 38J AB	27,0	1,06	7,7	0,30	10,3	1,0	19,1	0,75	14	3500	240

### AUTOMATIC BUTTWELD REDUCING ELBOW WITH SHOULDERS

### COUDE REDUCTION AVEC COLLERETTES POUR SOUDURE AUTOMATIQUE BOUT A BOUT

### WINKEL REDUZIER-SCHWEISSTÜCK, MIT WULST

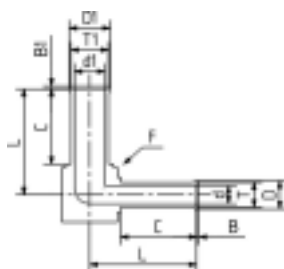

T1 Tube O.D.	T Tube O.D.	Part Number	L		d1	D1	B1	d	D	B	C		F	Working Pressure	
			mm	INCH	mm	mm	mm	mm	mm	mm	mm	INCH	mm	PSIG	BAR
<b>Fractional</b>															
3/8"	1/4"	RE 38 14 AB	27,0	1,06	7,7	10,5	0,8	4,6	7,4	0,5	19,1	0,75	14	3300	220
1/2"	1/4"	RE 12 14 AB	30,0	1,18	10,2	14,0	1,0	4,6	7,4	0,5	19,1	0,75	17	3500	240

# GAZEL® Weld Fittings

TEES

TES

T-STÜCKE

**AUTOMATIC BUTTWELD TEE WITHOUT SHOULDER**  
**TE SANS COLLERETTE POUR SOUDURE AUTOMATIQUE BOUT A BOUT**  
**T-SCHWEISSTÜCK OHNE WULST**



T Tube O.D.	Part Number	L		d		C		F	Worki Presst	
		mm	INCH	mm	INCH	mm	INCH		mm	PSIG
<b>Fractional</b>										
1/4"	T 14 ABW	27,0	1,06	4,6	0,18	19,1	0,75	10	5100	
1/4"	TCA 14 ABW	31,2	1,23	4,6	0,18	19,1	0,75	10	5100	
3/8"	T 38 ABW	27,0	1,06	7,7	0,30	19,1	0,75	14	3300	
3/8"	TCA 38 ABW	30,5	1,20	7,7	0,30	19,1	0,75	14	3300	
1/2"	T 12 ABW	30,0	1,18	10,2	0,40	19,1	0,75	17	3500	
1/2"	TCA 12 ABW	34,0	1,34	10,2	0,40	19,1	0,75	17	3500	
3/4"	T 34 ABW	35,0	1,38	16,5	0,65	19,1	0,75	24	3500	
1"	T 100 ABW	40,0	1,57	22,1	0,87	24,4	0,96	35	2400	
<b>Metric</b>										
6mm	T 6M ABW	27,0	1,06	4,0	0,16	19,1	0,75	10	6800	
6mm	TCA 6M ABW	31,2	1,23	4,0	0,16	19,1	0,75	10	6800	
8mm	T 8M ABW	27,0	1,06	6,0	0,24	19,1	0,75	14	4900	
10mm	T 10M ABW	27,0	1,06	8,0	0,31	19,1	0,75	14	3500	
12mm	T 12M ABW	30,0	1,18	10,0	0,39	19,1	0,75	17	3100	
12mm	TCA 12M ABW	34,0	1,34	10,0	0,39	19,1	0,75	17	3100	
<b>Jis</b>										
1/4"	T 14J ABW ①	27,0	1,06	4,4	0,17	19,1	0,75	10	5600	
3/8"	T 38J ABW ①	27,0	1,06	7,5	0,29	19,1	0,75	14	3500	

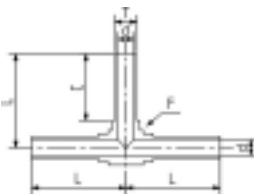

**AUTOMATIC BUTTWELD REDUCING TEE WITHOUT SHOULDER**  
**TE REDUCTION SANS COLLERETTE POUR SOUDURE AUTOMATIQUE BOUT A BOUT**  
**KOMBI REDUZIER T-SCHWEISSTÜCK OHNE WULST**



T1 Tube O.D.	T Tube O.D.	Part Number	L		d1		d		C		F	Work Presst	
			mm	INCH	mm	INCH	mm	INCH	mm	INCH		mm	PSIG
<b>Fractional</b>													
3/8"	1/4"	RT 38 14 ABW	27,0	1,06	7,7	0,30	4,6	0,18	19,1	0,75	14	3300	
1/2"	1/4"	RT 12 14 ABW	30,0	1,18	10,2	0,40	4,6	0,18	19,1	0,75	17	3500	
1/2"	3/8"	RT 12 38 ABW	30,0	1,18	10,2	0,40	7,7	0,30	19,1	0,75	17	3300	
<b>Metric</b>													
8mm	6mm	RT 8M 6M ABW	27,0	1,06	6,0	0,24	4,0	0,16	19,1	0,75	14	4800	
12mm	6mm	RT 12M 6M ABW	30,0	1,18	10,0	0,39	4,0	0,16	19,1	0,75	17	3100	
12mm	8mm	RT 12M 8M ABW	30,0	1,18	10,0	0,39	6,0	0,24	19,1	0,75	17	3100	
18mm	6mm	RT 18M 6M ABW	35,0	1,38	15,0	0,59	4,0	0,16	19,1	0,75	24	3000	
18mm	12mm	RT 18M 12M ABW	35,0	1,38	15,0	0,59	10,0	0,39	19,1	0,75	24	3000	
<b>Jis</b>													
3/8"	1/4"	RT 38J 14J ABW ①	27,0	1,06	7,5	0,29	4,4	0,17	19,1	0,75	14	3500	
1/2"	1/4"	RT 12 14J ABW ①	30,0	1,18	10,2	0,40	4,4	0,17	19,1	0,75	17	3500	
1/2"	3/8"	RT 12 38J ABW ①	30,0	1,18	10,2	0,40	7,5	0,29	19,1	0,75	17	3500	

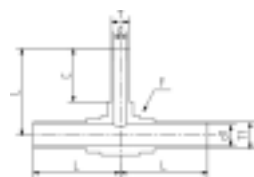

① On request, it can be delivered with C = 10mm (Example: TS 14J ABW)

# GAZEL® Weld Fittings

TEES

TES

T-STÜCKE

## AUTOMATIC BUTTWELD REDUCING TEE TE REDUCTION POUR SOUDURE AUTOMATIQUE BOUT A BOUT KOMBI REDUZIER T-SCHWEISSTÜCK

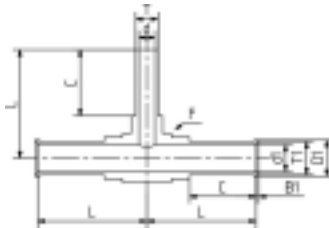

T1 Tube O.D.	T Tube O.D.	Part Number	L		d1	D1	B1	d	C		F	Working Pressure	
			mm	INCH	mm	mm	mm	mm	mm	INCH	mm	PSIG	BAR
<b>Fractional</b>													
3/8"	1/4"	RTCA 38 14W	31,2	1,23	31,2	10,5	0,8	4,6	19,1	0,75	14	3300	220
1/2"	1/4"	RTCA 12 14W	34,5	1,36	35,0	14,0	1,0	4,6	19,1	0,75	17	3500	240
1/2"	3/8"	RTCA 12 38W	34,3	1,35	35,0	14,0	1,0	7,7	19,1	0,75	17	3300	220
<b>Metric</b>													
12mm	6mm	RTCA 12M 6M W	34,5	1,36	35,0	13,2	1,0	4,0	19,1	0,75	17	3100	210

## AUTOMATIC BUTTWELD TEE TE POUR SOUDURE AUTOMATIQUE BOUT A BOUT T-SCHWEISSTÜCK

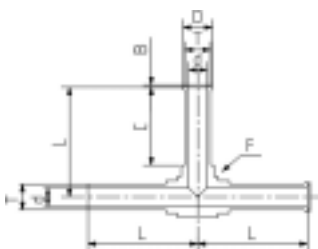

T Tube O.D.	Part Number	L		d		D	B	C		F	Working Pressure	
		mm	INCH	mm	INCH	mm	mm	mm	INCH	mm	PSIG	BAR
<b>Fractional</b>												
1/4"	MTCA 14 AB	31,2	1,23	4,6	0,18	7,4	0,5	19,1	0,75	10	5100	350
3/8"	MTCA 38 AB	30,5	1,20	7,7	0,30	10,5	0,8	19,1	0,75	14	3300	220
1/2"	MTCA 12 AB	34,0	1,34	10,2	0,40	14,0	1,0	19,1	0,75	17	3500	240

# GAZEL® Weld Fittings

## TEES

## TES

## T-STÜCKE

### AUTOMATIC BUTTWELD TEE WITH SHOULDERS TE AVEC COLLERETTES POUR SUDURE AUTOMATIQUE BOUT A BOUT T-SCHWEISSTÜCK MIT WULST

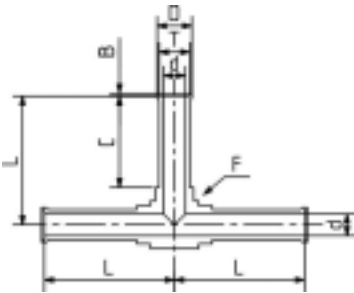

T Tube O.D.	Part Number	L		d		D	B	C		F	Working Pressure	
		mm	INCH	mm	INCH	mm	mm	mm	INCH	mm	PSIG	BAR
<b>Fractional</b>												
1/4"	T 14 AB	27,0	1,06	4,6	0,18	7,4	0,5	19,1	0,75	10	5100	350
1/4"	TCA 14 AB	31,7	1,25	4,6	0,18	7,4	0,5	19,1	0,75	10	5100	350
3/8"	T 38 AB	27,0	1,06	7,7	0,30	10,5	0,8	19,1	0,75	14	3300	220
3/8"	TCA 38 AB	31,2	1,23	7,7	0,30	10,5	0,8	19,1	0,75	14	3300	220
1/2"	T 12 AB	30,0	1,18	10,2	0,40	14,0	1,0	19,1	0,75	17	3500	240
1/2"	TCA 12 AB	35,0	1,38	10,2	0,40	14,0	1,0	19,1	0,75	17	3500	240
3/4"	T 34 AB	35,0	1,38	16,5	0,65	20,3	1,0	19,1	0,75	24	2400	160
1"	T 100 AB	40,0	1,57	22,1	0,87	26,9	1,0	24,4	0,96	35	2400	160
<b>Metric</b>												
6mm	T 6M AB	27,0	1,06	4,0	0,16	6,9	0,5	19,1	0,75	10	6800	460
6mm	TCA 6M AB	31,8	1,25	4,0	0,16	6,9	0,5	19,1	0,75	10	6800	460
8mm	T 8M AB	27,0	1,06	6,0	0,24	8,9	0,8	19,1	0,75	14	4800	330
8mm	TCA 8M AB	32,0	1,26	6,0	0,24	8,9	0,8	19,1	0,75	14	4800	330
10mm	T 10M AB	27,0	1,06	8,0	0,31	10,9	0,8	19,1	0,75	14	3500	240
10mm	TCA 10M AB	34,8	1,37	8,0	0,31	10,9	0,8	19,1	0,75	14	3500	240
12mm	T 12M AB	30,0	1,18	10,0	0,39	13,2	1,0	19,1	0,75	17	3100	210
12mm	TCA 12M AB	35,0	1,38	10,0	0,39	13,2	1,0	19,1	0,75	17	3100	210
18mm	TCA 18M AB	38,6	1,52	15,0	0,59	19,2	1,0	19,1	0,75	24	3000	200
<b>Jis</b>												
1/4"	T 14J AB	27,0	1,06	4,4	0,17	7,2	0,5	19,1	0,75	10	5600	380
3/8"	T 38J AB	27,0	1,06	7,5	0,30	10,3	0,8	19,1	0,75	14	3500	240

### AUTOMATIC BUTTWELD REDUCING TEE WITH SHOULDERS TE REDUCTION AVEC COLLERETTES POUR SUDURE BOUT A BOUT REDUZIER T-SCHWEISSTÜCK, MIT WULST

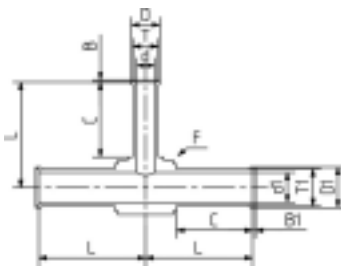

T1 Tube O.D.	T Tube O.D.	Part Number	L		d1	D1	B1	d	D	B	C		F	Working Pressure	
			mm	INCH	mm	mm	mm	mm	mm	mm	INCH	mm	PSIG	BAR	
<b>Fractional</b>															
3/8"	1/4"	RT 38 14 AB	27,0	1,06	7,7	7,4	0,8	4,6	7,4	0,5	19,1	0,75	14	3300	220
3/8"	1/4"	RTCA 38 14 AB	31,8	1,25	7,7	10,5	0,8	4,6	7,4	0,5	19,1	0,75	14	3300	220
1/2"	1/4"	RT 12 14 AB	30,0	1,18	10,2	14,0	1,0	4,6	7,4	0,5	19,1	0,75	17	3500	240
1/2"	1/4"	RTCA 12 14 AB	35,0	1,38	10,5	14,0	1,0	4,6	7,4	0,5	19,1	0,75	17	3500	240
1/2"	3/8"	RT 12 38 AB	30,0	1,18	10,2	14,0	1,0	7,7	10,5	0,8	19,1	0,75	17	3300	220
1/2"	3/8"	RTCA 12 38 AB	35,0	1,38	10,5	20,3	1,0	7,7	10,5	0,8	19,1	0,75	17	3300	220
3/4"	3/8"	RT 34 38 AB	35,0	1,38	16,5	20,3	1,0	7,7	10,5	0,8	19,1	0,75	24	2400	160
3/4"	1/2"	RT 34 12 AB	35,0	1,38	16,5	20,3	1,0	10,2	14,0	1,0	19,1	0,75	24	2400	160
<b>Metric</b>															
12mm	6mm	RT 12M 6M AB	30,0	1,18	10,0	13,2	1,0	4,0	6,9	0,5	19,1	0,75	17	3100	210
12mm	6mm	RTCA 12M 6M AB	34,0	1,34	10,0	13,2	1,0	4,0	6,9	0,5	19,1	0,75	17	3100	210
12mm	8mm	RT 12M 8M AB	30,0	1,18	10,0	13,2	1,0	6,0	6,9	0,5	19,1	0,75	17	3100	210
<b>Jis</b>															
3/8"	1/4"	RT 38J 14J AB	27,0	1,06	7,7	10,3	0,80	4,4	7,2	0,5	19,1	0,75	14	3500	240
1/2"	1/4"	RT 12 14J AB	30,0	1,18	10,2	14	1,00	4,4	7,2	0,5	19,1	0,75	17	3500	240
1/2"	3/8"	RT 12 38J AB	30,0	1,18	10,2	14	1,00	7,5	10,3	0,8	19,1	0,75	17	3500	240

# GAZEL® Weld Fittings

## CROSSES

## CROIX

## KREUZSTÜCKE

### AUTOMATIC BUTTWELD CROSS WITHOUT SHOULDER CROIX SANS COLLERETTE POUR SOUDURE AUTOMATIQUE BOUT A BOUT KREUZSCHWEISSTÜCK OHNE WULST

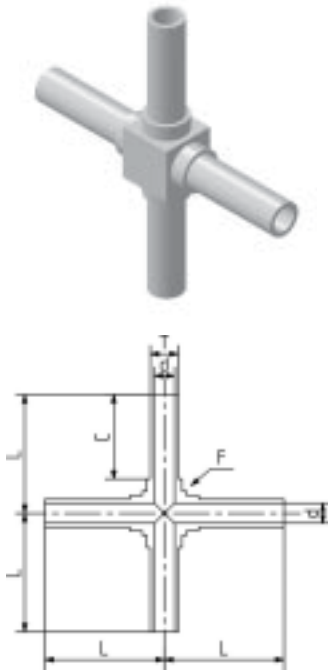

T Tube O.D.	Part Number	L		d		C		F	Working Pressure		
		mm	INCH	mm	INCH	mm	INCH		mm	PSIG	BAR
<b>Fractional</b>											
1/4"	C 14 ABW	27,0	1,06	4,6	0,18	19,1	0,75	10	5100	350	
3/8"	C 38 ABW	27,0	1,06	7,7	0,30	19,1	0,75	14	3300	220	
1/2"	C 12 ABW	30,0	1,18	10,2	0,40	19,1	0,75	17	3500	240	
<b>Metric</b>											
6mm	C 6M ABW	27,0	1,06	4,0	0,16	19,1	0,75	10	6800	460	
8mm	C 8M ABW	27,0	1,06	6,0	0,24	19,1	0,75	14	4800	330	
12mm	C 12M ABW	30,0	1,18	10,0	0,39	19,1	0,75	17	3100	210	

### AUTOMATIC BUTTWELD CROSS WITH SHOULDERS CROIX AVEC COLLERETTES POUR SOUDURE AUTOMATIQUE BOUT A BOUT KREUZSCHWEISSTÜCK MIT WULST



T Tube O.D.	Part Number	L		d		D	B	C		F	Working Pressure	
		mm	INCH	mm	INCH			mm	INCH		mm	PSIG
<b>Fractional</b>												
1/4"	C 14 AB	27,0	1,06	4,6	0,18	7,4	0,5	19,1	0,75	10	5100	350
1/4"	CCA 14 AB	31,8	1,25	4,6	0,18	7,4	0,5	19,1	0,75	10	5100	350
3/8"	C 38 AB	27,0	1,06	7,7	0,30	10,5	0,8	19,1	0,75	14	3300	220
3/8"	CCA 38 AB	31,2	1,23	7,7	0,30	10,5	0,8	19,1	0,75	14	3300	220
1/2"	C 12 AB	30,0	1,18	10,2	0,40	14,0	1,0	19,1	0,75	17	3500	240
1/2"	CCA 12 AB	34,3	1,35	10,2	0,40	14,0	1,0	19,1	0,75	17	3500	240
<b>Metric</b>												
6mm	C 6M AB	27,0	1,06	4,0	0,16	6,9	0,5	19,1	0,75	10	6800	460
6mm	CCA 6M AB	31,2	1,23	4,0	0,16	6,9	0,5	19,1	0,75	10	6800	460
8mm	C 8M AB	27,0	1,06	6,0	0,24	8,9	0,8	19,1	0,75	14	4800	330
8mm	CCA 8M AB	31,2	1,23	6,0	0,24	8,9	0,8	19,1	0,75	14	4800	330
10mm	CCA 10M AB	32,5	1,28	8,0	0,31	10,9	0,8	19,1	0,75	14	3500	240
12mm	CCA 12M AB	32,5	1,28	10,0	0,39	13,2	1,0	19,1	0,75	17	3100	210