

Messing G

Verschraubungen

























Laiton G

Raccords

Brass G

Unions



	Seite/Page/Page		Seite/Page/Page		Seite/Page/Page
Klemmring Bague de serrage Compression ferrule	4G.4-4G.5  SO 00001	Anschlussnippel Ecrrou de raccordement mâle Nipple connection	4G.19-4G.20  SO 01001	Anschlusswinkel Coude femelle Female adaptor elbow union	4G.34  SO 02321
Abschlusszapfen Bouchon d'arrêt Plug	4G.6  SO 00002	Gerade Verschraubung Union double Straight union	4G.21-4G.22  SO 01011	Winkel-Einschraubverschraubung Coude mâle Male adaptor elbow union	4G.35-4G.36  SO 02421
Stützhülse Douille d'appui Stiffener sleeve	4G.7-4G.8  SO 40003	Gerade Einschraubverschraubung Union mâle Male adaptor union	4G.23-4G.26  SO 01121	Winkel-Aufschraubverschraubung Coude femelle Female adaptor elbow union	4G.37  SO 02521
Dichtung für Innengewinde Joint pour filetage femelle Washer for female threads	4G.9  SO 40005	Gerade Aufschraubverschraubung Union femelle Female adaptor union	4G.27-4G.28  SO 01221	Winkelverschraubung Coude orientable Adjustable elbow union	4G.38  SO 02621
Anschlussmutter Ecrrou Union nut	4G.12  SO 00020	Verschraubung Union Adaptor union	4G.29  SO 01421	Winkel-Schottverschraubung Coude pour passage de cloison Panel mount elbow union	4G.39  SO 02721
Armaturenanschluss Ecrrou de raccordement Nut connection	4G.13-4G.14  SO 00021	Gerade Schottverschraubung Union double pour passage de cloison Panel mount union	4G.30-4G.31  SO 01521	T-Verschraubung Té Tee union	4G.40-4G.42  SO 03021
Übergangsmuffe Adaptateur femelle Female adaptor	4G.15-4G.16  SO 00030	Einstellnippel Union orientable mâle Adjustable male adaptor	4G.32-4G.33  SO 41600	T-Verschraubung Té orientable Adjustable Tee union	4G.43  SO 03621 T
Übergangsnippel Adaptateur mâle Male adaptor	4G.17-4G.18  SO 00040	Winkelverschraubung Coude Elbow union	4G.33  SO 02021	L-Verschraubung L orientable Adjustable L union	4G.43  SO 03621 L

Seite/Page/Page

Seite/Page/Page

T-Einschraubverschraubung
T mâle
Male adaptor Tee union



4G.44
SO 03721 T

Winkel zylindrisch
Coude cylindrique
Elbow union parallel



4G.53
SO 02000

L-Einschraubverschraubung
L mâle
Male adaptor L union



4G.44
SO 03721 L

Winkel zylindrisch/kegelig
Coude cylindrique/conique
Elbow union parallel/tapered



4G.54
SO 02400

Kreuzverschraubung
Croix
Cross union



4G.45
SO 04021

T-Stück zylindrisch
Pièce Té cylindrique
Tee parallel



4G.54
SO 03000

Winkel-Verteilerverschraubung
Distributeur
V distributor union



4G.46
SO 05021

Sonderausführungen:
Exécution en option:
Optional Services:



Spezialbehandlung für Einsatz mit Sauerstoff
Traitement spécial pour utilisation sous oxygène
Special treatment for use with oxygen



Spezialbehandlung - silikonfrei
Traitement spécial - sans silicone
Special treatment - silicone free



Spezialreinigung - entfettet
Traitement spécial - sans silicone
Special treatment - degreased



Vorbeschichtete Gewinde mit Loctite 5061
Filetages pré enduits avec Loctite 5061
Pre-coated threads with Loctite 5061



Vorbeschichtete Gewinde PTFE-Band umwickelt
Filetages pré enduits avec ruban en PTFE
Pre-coated threads with PTFE-tape



Chemisch vernickelt
Nickelage chimique
Chemical nickel-plated



Messing bleifrei
Laiton sans plomb
Unleaded brass

Doppelnippel zylindrisch
Adaptateur mâle cylindrique
Male adaptor parallel



4G.51
SO 01020

Doppelnippel zylindrisch/kegelig
Nipple mâle cylindrique/conique
Male adaptor nipple parallel/tapered



4G.51
SO 01100

Anschlussmuffe zylindrisch
Adaptateur femelle cylindrique
Female adaptor



4G.52
SO 01200

Schott-Doppelnippel zylindrisch
Adaptateur mâle cylindrique pour cloison
Panel male adaptor parallel



4G.53
SO 01500

Sonderausführung für Adapter
siehe Kapitel 9

Exécution en option pour adaptateurs
voir chapitre 9

Option services for adaptors
see chapter 9

Messing G

Laiton G

Brass G

Eigenschaften, Besonderheiten

- einfache, schnelle Montage
- kompakte Baumassee
- grosse Sortimentsvielfalt
- sehr viele Kombinationsmöglichkeiten
- zwei Ausführungen:
M = Anschlussmutter metrisch
G = Anschlussmutter Rohrgewinde (Zoll)
(M und G nicht austauschbar)

Funktionsprinzip

siehe Anhang

Werkstoff

Messing CuZn40Pb2 (CW 617N). Oberfläche gebeizt.
Chemisch vernickelt, siehe Kapitel 8.

Nenndruck PN

siehe Produktetabellen (4fache Sicherheit).
Dynamische Belastungen auf Anfrage.

Temperaturbereich

-40°C bis +180°C.

Vakuum

Bis 10⁻⁴mbar, höhere Werte möglich.

Anzuschliessende Rohre

Kunststoffrohre und nahtlose, gezogene Kupferrohre (insbes. EN 12449/1057) mit sauberer, glatter Oberfläche, Aussendurchmesser innerhalb ± 0,1 mm. Siehe auch Kapitel Rohre und Schläuche. Weitere Materialien auf Anfrage.

Zulassungen

SVGW, DVGW und ÖVGW

Einschraubzapfen, Gewinde

Rohrgewinde (Zoll) und metrisches Feingewinde DIN 3852, kegelig Form C, zylindrisch Form B, mit Dichtkante Form E. NPT-Gewinde nach ANSI/ASME B1.20.1-1983.

Généralités

- montage facile et rapide
- compactes dimensions
- programme étendu
- multiples possibilités de combinaisons
- deux exécutions:
M = Ecrou SERTO avec filetage métrique
G = Ecrou SERTO avec filetage (BSP) gaz
(M et G ne sont pas interchangeables)

Principe de fonctionnement

voir annexe

Matériau

Laiton CuZn40Pb2 (CW 617N). La surface est décapée.
Nickelée par voie chimique, voir chapitre 8.

Pression nominale PN

voir tableaux des produits (facteur de sécurité 4). Sollicitations dynamique sur demande.

Plage de température admissible

-40°C à +180°C.

Vide

Jusqu'à 10⁻⁴mbar, plus poussé possible.

Tubes à utiliser

Tubes en matière plastique et tous les tubes en cuivre sans soudure (selon EN 12449/1057) avec surface propre et lisse. Le diamètre extérieur doit être situé dans une tolérance de ± 0,1 mm. Voir chapitre tubes et tuyaux. Autres matériaux sur demande.

Homologations

SSIGE, DVGW et ÖVGW

Embouts mâles, filetages

Filetage gaz (BSP) et filetage métrique à pas fin DIN 3852. Conique selon forme C. Cylindrique selon forme B. Filetage d'étanchéité selon forme E. Filetage NPT selon ANSI/ASME B1.20.1-1983.

Characteristics, specialities

- easy and fast to install
- compact size
- extensive range
- many combination possibilities
- two models:
M = Connection nut with metric thread
G = Connection nut with British Standard Pipe (BSP) thread
(M and G are not interchangeable)

Operating principle

see appendix

Material

Brass CuZn40Pb2 (CW 617N). The surface is pickled.
Chemically nickel plated, see chapter 8.

Nominal pressure PN

see product table (safety factor 4). Dynamic loads on demand.

Temperature range

-40°C to +180°C.

Vacuum

Up to 10⁻⁴mbar, higher values are possible.

Tubes to use

Tubes of plastic and seamless copper tubes (esp. EN 12449/1057) with clean smooth surface, outside diameter of ± 0,1 mm. See also chapter tubes and hoses. Further materials on demand.

Approvals

SVGW, DVGW and ÖVGW

Adaptor stem, male thread

British Standard Pipe (BSP) and metric fine thread DIN 3852. Tapered form C, parallel form B. Thread with sealing form E. BSP-thread according to ANSI/ASME B1.20.1-1983.

Druckauswertungsgrad in % des PN

Coefficient de pression de service admissible en % de PN

Pressure coefficient % of PN

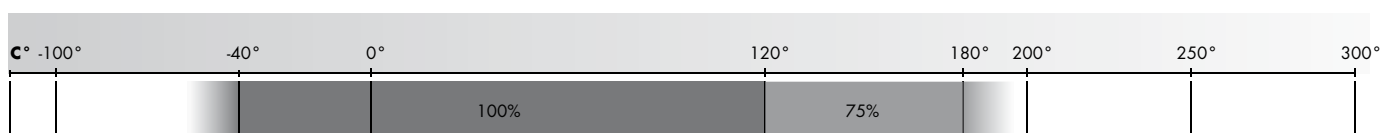

Klemmring
Bague de serrage
Compression ferrule

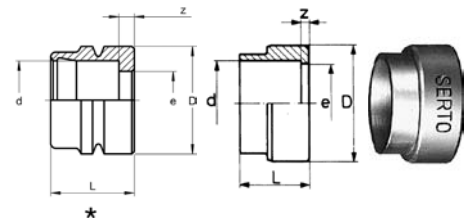

SO 00001

Type -d	Mat.-Nr.	bar	L	D	z	e	kg/100
Für metrische Rohre	Pour tubes métriques		For metric tubes				
SO 40001-4	016.0010.040	125	5.0	6.0	1.0	3.5	0.060
SO 40001-5	016.0010.050	125	5.5	6.8	1.0	4.0	0.060
SO 40001-6 *	016.0010.060	250	6.5	8.4	1.2	4.5	0.120
SO 00001-8	246.0010.080	125	7.0	11.0	1.0	7.0	0.190
SO 00001-10	246.0010.100	100	8.0	13.5	1.0	9.0	0.330
SO 00001-12	246.0010.120	100	10.0	16.0	1.2	11.0	0.550
SO 00001-14	246.0010.140	64	12.0	18.0	1.5	13.0	0.780
SO 00001-15	246.0010.150	64	12.0	18.5	1.5	14.0	0.770
SO 00001-17	246.0010.170	64	12.0	21.0	1.5	16.0	0.920
SO 00001-18	246.0010.180	64	14.0	23.0	1.5	16.0	1.420
SO 00001-22	246.0010.220	40	14.0	27.0	1.5	20.0	1.690

Für Zollrohre	Pour tubes pouces		For inch tubes				
SO 40001-6,35	016.0010.063	100	6.5	8.4	1.2	4.5	0.120
SO 00001-7,94	246.0010.079	125	7.0	11.0	1.0	7.0	0.190
SO 00001-9,52	246.0010.095	100	8.0	13.0	1.0	8.0	0.320
SO 00001-12,7	246.0010.127	100	10.0	17.0	1.2	11.0	0.610



Klemmring

für Manometeranschluss

Bague de serrage

pour écrou de manomètre

Compression ferrule

for pressure gauge connection

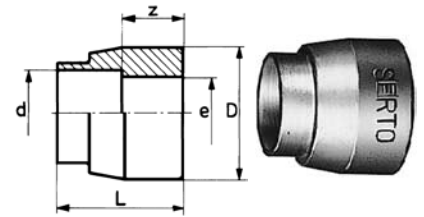

SO 00001 MAN

Type -d-G	Mat.-Nr.	bar	L	D	z	e	kg/100
Für metrische Rohre		Pour tubes métriques					
G=Rohrgewinde (zylindrisch)		G=Filetage-gaz BSP (cylindrique)					
SO 00001-6-1/4 MAN	246.0011.110	125	8.5	9.0	3.5	5.5	1.980
SO 00001-6-1/2 MAN	246.0011.125	125	11.5	10.0	6.5	5.0	3.240
SO 00001-8-1/2 MAN	246.0011.185	125	11.5	12.0	5.5	6.5	5.320

Whitworth-Rohrgewinde

Diese Klemmringe «SO 00001 MAN» dürfen nur mit der Anschlussmutter für Manometer verwendet werden, deren Bestellnummer «MAN» enthält.

Für alle anderen Manometeranschlüsse wird der Klemmring SO 00001 verwendet.

G = Gewindeanschluss am Manometer

Filetage Whitworth-gaz

Les bagues de serrage «SO 00001 MAN» doivent être utilisées uniquement avec les écrous portant la désignation «MAN». Pour d'autres dimensions, utiliser la bague de serrage SO 00001.

G = Filetage de raccordement au manomètre

Whitworth pipe thread

These compression ferrules «SO 00001 MAN» must only be used with the union nut for pressure gauges of which the order number contains «MAN». For all other pressure gauge connections the compression ferrule SO 00001 is to be used.

G = thread connection on pressure gauge.

Klemmring

für Messleitung

Bague de serrage

pour conduite de mesure

Compression ferrule

for gauge lines

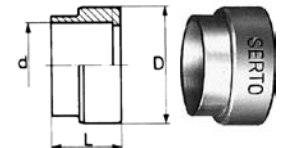

SO 00001 D

Type -d-G	Mat.-Nr.	bar	L	D	kg/100
Für metrische Rohre		Pour tubes métriques			
SO 40001-4 D	016.0012.040	125	5.0	6.0	0.050
SO 40001-6 D	016.0012.060	100	6.5	8.5	0.100
SO 40001-6-4 D	016.0012.110	100	8.5	6.0	0.220
SO 00001-8 D	246.0012.080	100	7.0	11.0	0.190
SO 00001-10 D	246.0012.100	64	8.0	13.5	0.330
SO 00001-12 D	246.0012.120	64	10.0	16.0	0.550
SO 00001-14 D	246.0012.140	40	12.0	18.0	0.780
SO 00001-15 D	246.0012.150	40	12.0	18.5	0.770

Abschlusszapfen
Bouchon d'arrêt
Plug

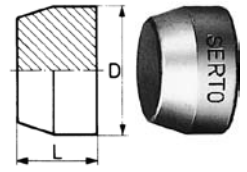

SO 00002

Type -d	Mat.-Nr.	L	D	kg/100
Für metrische Rohre	Pour tubes métriques		For metric tubes	
SO 40002-4	016.0020.040	8.0	6.8	0.150
SO 40002-5	016.0020.050	8.5	6.8	0.190
SO 40002-6	016.0020.060	10.0	8.4	0.310
SO 00002-8	246.0020.080	6.0	10.0	0.390
SO 00002-10	246.0020.100	7.0	12.0	0.660
SO 00002-12	246.0020.120	9.5	13.8	1.180
SO 00002-14	246.0020.140	8.0	17.0	1.500
SO 00002-15	246.0020.150	10.5	17.0	1.900
Für Zollrohre	Pour tubes pouces		For inch tubes	
SO 40002-6,35	016.0020.063	10.0	8.4	0.310
SO 00002-7,94	246.0020.079	10.5	10.5	0.570
SO 00002-9,52	246.0020.095	13.0	12.7	0.960
SO 00002-12,7	246.0020.127	14.0	14.8	1.470

4G

Anwendungsbeispiele:

Exemples d'utilisation:

Sample combinations:

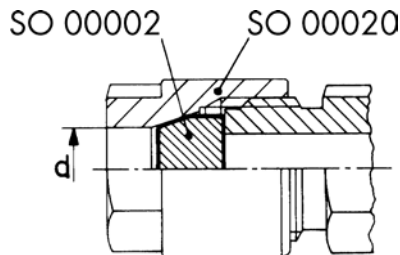

Werkstoff: Messing
Der Abschlusszapfen lässt sich in jede Verschraubung anstelle eines Klemmringes gleicher Größe d einsetzen. Anschlussmutter mit 1/4 Drehung anziehen.

Matériau: Laiton
Le bouchon d'arrêt peut remplacer la bague de serrage de même dimension d dans chaque raccord. Serrer l'écrou avec 1/4 tour.

Material: Brass
The plug can be fitted into any union in place of a compression ferrule of same diameter d. Tighten the union nut with 1/4 turn.

Stützhülse

zur Rohrverstärkung

Douille d'appui

pour renforcer les tubes

Stiffener sleeve

to reinforce the tubes

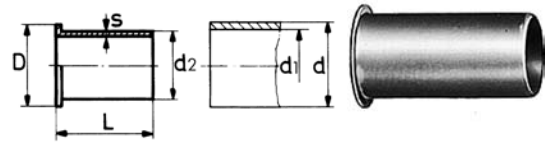

SO 40003

Type - d - d1	Mat.-Nr.	L	D	s	kg/100
Für metrische Rohre	Pour tubes métriques			For metric tubes	
SO 40003-3-2	016.0030.020	6.0	2.8	0.20	0.006
SO 40003-3-2,4	016.0030.024	6.0	2.8	0.20	0.007
SO 40003-4-2	016.0030.030	8.0	3.8	0.20	0.008
SO 40003-4-2,5	016.0030.035	8.0	3.8	0.20	0.010
SO 40003-4-3	016.0030.040	8.0	3.8	0.20	0.010
SO 40003-5-3	016.0030.060	8.0	4.5	0.20	0.015
SO 40003-5-3,5	016.0030.075	8.0	4.5	0.20	0.020
SO 40003-6-3	016.0030.100	10.0	5.2	0.20	0.015
SO 40003-6-4	016.0030.110	10.0	5.5	0.20	0.025
SO 40003-6-4,4	016.0030.113	10.0	5.5	0.20	0.025
SO 40003-6-4,65	016.0030.116	10.0	5.5	0.20	0.025
SO 40003-6-4,7 D	016.0030.118	10.0	5.5	0.40	0.046
SO 40003-8-5	016.0030.136	12.0	7.5	0.25	0.040
SO 40003-8-5,5	016.0030.138	12.0	7.5	0.25	0.045
SO 40003-8-6	016.0030.140	12.0	7.5	0.25	0.045
SO 40003-8-6,4	016.0030.144	12.0	7.5	0.25	0.050
SO 40003-10-7	016.0030.180	16.0	9.5	0.30	0.080
SO 40003-10-7,5	016.0030.185	16.0	9.5	0.30	0.090
SO 40003-10-8	016.0030.190	16.0	9.5	0.30	0.100
SO 40003-10-8 D	016.0030.189	16.0	9.5	0.60	0.190
SO 40003-10-8,4	016.0030.192	16.0	9.5	0.30	0.095
SO 40003-10-8,6	016.0030.193	16.0	9.5	0.30	0.095
SO 40003-12-9	016.0030.230	20.0	11.5	0.40	0.190
SO 40003-12-9,5	016.0030.235	20.0	11.5	0.40	0.195
SO 40003-12-10	016.0030.240	20.0	11.5	0.40	0.195
SO 40003-12-10.4	016.0030.254	20.0	11.5	0.40	0.195
SO 40003-12-11 D	016.0030.257	20.0	12.0	1.00	0.500
SO 40003-13-11	016.0030.280	20.0	12.5	0.50	0.330
SO 40003-13-11 D	016.0030.279	20.0	12.5	1.00	0.530
SO 40003-14-11	016.0030.330	24.0	13.5	0.50	0.350
SO 40003-14-11,5	016.0030.335	24.0	13.5	0.50	0.350
SO 40003-14-12	016.0030.340	24.0	13.5	0.50	0.370
SO 40003-15-12,5	016.0030.425	24.0	14.5	0.50	0.390
SO 40003-15-13	016.0030.430	24.0	14.5	0.50	0.390

d=Rohrassen-ø
d1=Rohrinnendurchmesser
L= Mass in montiertem Zustand
s= Wandstärke

d=ø extérieur du tube
ø diam. Intérieur du tube
L=après montage
s=épaisseur de la paroi

d=tube outside diameter
d1=tube inside diameter
L=installed length
s=wall thickness

Stützhülse

für SERTOflex-Rohre

Douille d'appui

pour tubes SERTOflex

Stiffener sleeve

for SERTOflex tubes

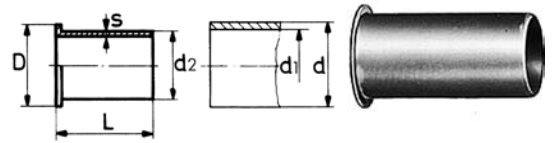

SO 40003 FLEX

Type -d -d1	Mat.-Nr.	L	D	s	kg/100
SO 40003-6-4 FLEX	440.0035.110	10.0	5.5	0.20	0.025
SO 40003-6,35-4,35 FLEX	440.0035.113	10.0	5.5	0.20	0.025
SO 40003-8-5,3 FLEX	440.0035.137	12.0	7.5	0.25	0.045
SO 40003-10-6,35 FLEX	440.0035.177	16.0	9.5	0.30	0.080
SO 40003-12-8 FLEX	440.0035.225	20.0	11.5	0.40	0.190
SO 40003-14-10 FLEX	440.0035.329	24.0	13.5	0.50	0.320
SO 40003-15-10,5 FLEX	440.0035.412	24.0	14.5	0.50	0.350

Werkstoff: Messing

Verstärken:

Dünnwandige und weiche Rohre sowie alle Kunststoffrohre sind vor dem Einführen in die SERTO Verschraubung mit Stützhülsen zu verstärken.

Matériau: Laiton

Renforcement:

Les tubes présentant une paroi mince, les tubes en matière souple ainsi que les tubes en matière plastique doivent être renforcés à l'aide de douilles d'appui avant d'être introduits dans les raccords SERTO.

Material: Brass

Reinforcement:

Thin walled and soft tubes and all plastic tubes, are to be reinforced with stiffener sleeves before introducing them into the SERTO union.

4G

d=Rohrassen-ø

d1=Rohrinnendurchmesser

L= Mass in montiertem Zustand

s= Wandstärke

d=ø extérieur du tube

ø diam. Intérieur du tube

L=après montage

s=épaisseur de la paroi

d=tube outside diameter

d1=tube inside diameter

L=installed length

s=wall thickness

Dichtung für Innengewinde

Joint pour filetage femelle

Washer for female threads

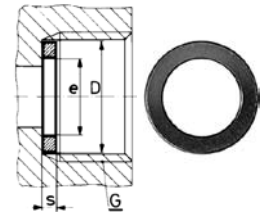

SO 40005

Type -d-G-e	Mat.-Nr.	D	s	e	kg/100
G=Rohrgewinde (zylindrisch)	G=Filetage-gaz BSP (cylindrique)	G=BSP thread (straight)			
SO 40005-4- $\frac{1}{8}$	016.0050.060	8.5	2.00	4.0	0.070
SO 40005-5- $\frac{1}{8}$	016.0050.082	8.5	2.00	4.0	0.070
SO 40005-6- $\frac{1}{4}$	016.0050.110	11.2	2.00	5.2	0.130
SO 40005-8- $\frac{1}{4}$	016.0050.170	11.2	2.00	6.8	0.090
SO 40005-8,2- $\frac{1}{4}$	016.0050.173	11.2	2.00	8.2	0.080
SO 40005-10- $\frac{3}{8}$	016.0050.280	14.8	2.00	9.0	0.170
SO 40005-10,2- $\frac{3}{8}$	016.0050.283	14.8	2.00	10.2	0.150
SO 40005-12- $\frac{1}{2}$	016.0050.400	18.5	2.00	10.0	0.330
SO 40005-14- $\frac{1}{2}$	016.0050.504	18.5	2.00	13.5	0.210
SO 40005-15- $\frac{1}{2}$	016.0050.534	18.5	2.00	13.5	0.210
SO 40005-15- $\frac{3}{4}$	016.0050.536	24.0	2.00	14.2	0.490
SO 40005-17- $\frac{3}{4}$	016.0050.598	24.0	2.00	16.2	0.410
SO 40005-18- $\frac{7}{8}$	016.0050.650	27.8	2.00	16.2	0.700
SO 40005-22-1	016.0050.770	30.0	2.00	20.0	0.670

Anwendungsbeispiele:

Exemples d'utilisation:

Sample combinations:

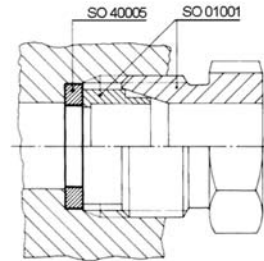
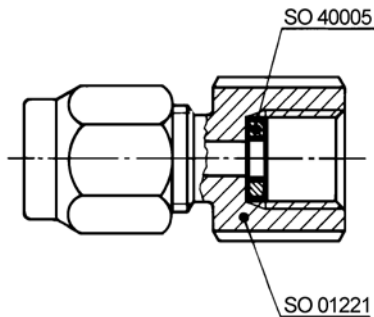

Material: Kupfer, weich

Matériau: Cuivre, doux

Material: Copper, soft

Zu verwenden:

Als Auflage für den Klemmring beim Einschraubstutzen SO 01001. Als stirnseitige Abdichtung in Anschlussgewinde der Verschraubung SO 00030 und SO 01221.

Emploi:

Comme appui d'étanchéité pour la bague de serrage SO 01001. Comme joint frontal pour le filetage femelle des pièces SO 00030 et SO 01221.

Application:

As seat for compression ferrule with nipple connection SO 01001. As butt seal for adaptor thread in unions SO 00030 and SO 01221.

Sechskantmutter
Ecrou à six pans
Hexagon nut

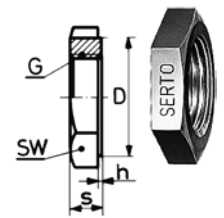

SO 40006

Type -G	Mat.-Nr.	SW	D	s	kg/100
Für metrische Rohre		Pour tubes métriques		For metric tubes	
G=Rohrgewinde (zylindrisch)		G=Filetage-gaz BSP (cylindrique)		G=BSP thread (straight)	
SO 40006-1/8	016.0061.020	14	13.8	5.00	0.410
SO 40006-1/4	016.0061.040	19	18.8	6.00	0.910
SO 40006-3/8	016.0061.060	24	23.8	6.00	1.430
SO 40006-1/2	016.0061.080	30	29.8	7.00	2.580

Dichtung für Aussengewinde
Joint pour filetage mâle
Washer for male thread

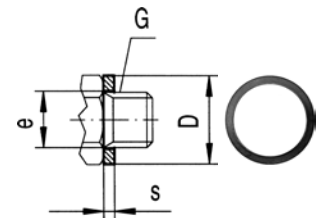

SO 40507

Type -d-G	Mat.-Nr.	D	s	e	kg/100
SO 40507-M5	016.0075.080	8.0	1.00	5.2	0.005
SO 40507-M5-2	016.0075.083	8.0	2.00	5.2	0.010
SO 40507-M6	016.0075.100	9.0	1.00	6.2	0.004
SO 40507-M8	016.0075.120	10.0	1.00	8.2	0.003
SO 40507-M10	016.0075.150	12.0	1.00	10.2	0.006

Material: Kunststoff POM

Matériau: Plastique POM

Material: Plastic POM

4G

Dichtung für Aussengewinde
Joint pour filetage mâle
Washer for male threads

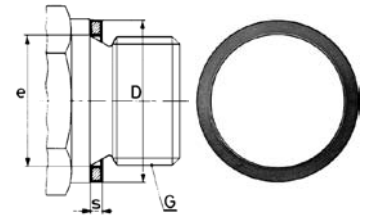

SO 40007

Type -G	Mat.-Nr.	D	s	e	kg/100
G=Rohrgewinde (zylindrisch)	G=Filetage-gaz BSP (cylindrique)	G=BSP thread (straight)			
SO 40007-1/8	016.0070.020	13.4	1.50	10.2	0.050
SO 40007-1/4	016.0070.040	17.9	1.50	14.2	0.110
SO 40007-3/8	016.0070.060	20.9	1.50	17.2	0.130
SO 40007-1/2	016.0070.080	25.9	1.50	21.2	0.220
SO 40007-3/4	016.0070.120	31.0	1.50	26.5	0.230

Dichtung für Aussengewinde METR
Joint pour filetage mâle METR
Washer for male threads METR

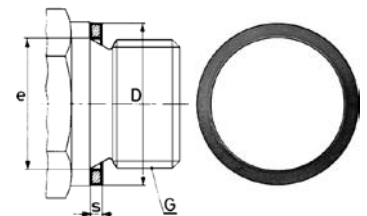

SO 40007 METR

Type -G	Mat.-Nr.	D	s	e	kg/100
SO 40007-M5	016.0073.080	8.0	1.00	5.2	0.023
SO 40007-M6	016.0073.100	8.0	1.00	6.2	0.014
SO 40007-M8	016.0073.173	11.2	2.00	8.2	0.080
SO 40007-M10	016.0073.150	13.4	1.50	10.2	0.050
SO 40007-M12	016.0073.190	15.4	1.50	12.2	0.080
SO 40007-M14	016.0073.220	17.9	1.50	14.2	0.110
SO 40007-M16	016.0073.260	19.9	1.50	16.2	0.120
SO 40007-M18	016.0073.300	22.0	1.50	18.2	0.140
SO 40007-M22	016.0073.370	27.0	1.50	22.2	0.225

Anwendungsbeispiele:

Exemples d'utilisation:

Sample combinations:

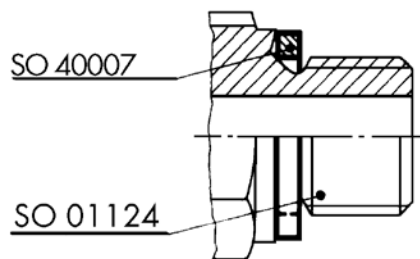

Material: Kupfer, weich

Matériau: Cuivre, doux

Material: Copper, soft

Ersatzdichtungen für Schwenkverschraubungen und Mehrfachverteiler.

Joints de rechange pour coudes banjo et coudes banjo multiples.

Replacement washer for single and double banjo.

Zu verwenden:

Emploi:

Application:

Als Abdichtung der Verschraubung mit zylindrischem Einschraubgewinde.

Rendre étanche un filetage cylindrique mâle

As seal for union with straight male adaptor thread.

d=Rohraussen-ø
 e= kleinste Bohrung
 s= Wandstärke

d=ø extérieur du tube
 e= ø-min. de passage
 s=épaisseur de la paroi

d=tube outside diameter
 e=minimum bore
 s=wall thickness

Anschlussmutter

Ecrou

Union nut

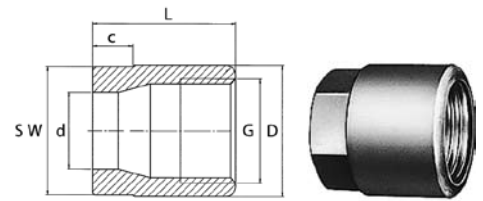

SO 00020

Type -d-G	Mat.-Nr.	bar	SW	L	kg/100
Für metrische Rohre G=Rohrgewinde (zylindrisch)	Pour tubes métriques G=Filetage-gaz BSP (cylindrique)			For metric tubes G=BSP thread (straight)	
SO 00020-4-1/8	246.0200.060	125	12	15.5	0.930
SO 00020-5-1/8	246.0200.082	125	12	15.5	0.900
SO 00020-6-1/8	246.0200.100	125	12	16.5	0.880
SO 00020-6-1/4	246.0200.110	125	14	18.5	1.960
SO 00020-6-3/8	246.0200.120	125	17	21.0	3.490
SO 00020-8-1/4	246.0200.170	125	14	19.0	1.810
SO 00020-8-3/8	246.0200.180	125	17	21.0	3.260
SO 00020-8-1/2	246.0200.185	125	19	23.5	5.360
SO 00020-10-3/8	246.0200.280	100	17	21.5	2.970
SO 00020-10-1/2	246.0200.285	100	19	24.0	4.970
SO 00020-12-1/2	246.0200.400	100	19	26.0	5.100
SO 00020-14-1/2	246.0200.504	64	22	28.5	5.520
SO 00020-15-1/2	246.0200.534	64	27	30.0	9.930

Für Zollrohre	Pour tubes pouces			For inch tubes	
SO 00020-6,35-1/8	246.0200.135	125	12	16.5	0.850
SO 00020-6,35-1/4	246.0200.140	125	14	18.5	2.010
SO 00020-9,52-3/8	246.0200.235	100	17	21.5	2.840
SO 00020-12,7-1/2	246.0200.434	100	22	27.0	5.590

4G

d= Rohraussen-ø
L= Mass in montiertem Zustand

d=ø extérieur du tube
L=après montage

d=tube outside diameter
L=installed length

Armaturenanschluss

Ecrou de raccordement

Nut connection

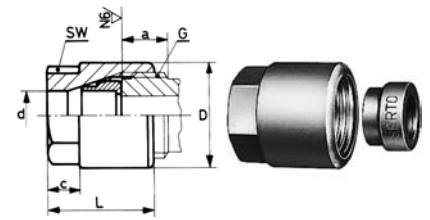
SO 00021

Type -d-G	Mat.-Nr.	bar	SW	L	a	c	D	kg/100
Für metrische Rohre	Pour tubes métriques			For metric tubes				
G=Rohrgewinde (zylindrisch)	G=Filetage-gaz BSP (cylindrique)			G=BSP thread (straight)				
SO 00021-4-1/8	246.0210.060	125	12	15.5	8.0	4.0	12.0	0.856
SO 00021-5-1/8	246.0210.082	125	12	15.5	8.0	6.0	12.0	0.909
SO 00021-6-1/8	246.0210.100	125	12	16.5	8.0	6.0	12.0	0.972
SO 00021-6-1/4	246.0210.110	125	14	18.0	8.0	6.0	17.0	2.000
SO 00021-6-3/8	246.0210.120	125	17	21.0	9.0	6.0	21.0	3.000
SO 00021-8-1/4	246.0210.170	125	14	19.0	8.0	6.0	17.0	2.000
SO 00021-8-3/8	246.0210.180	125	17	21.0	9.0	6.0	21.0	3.000
SO 00021-8-1/2	246.0210.185	125	19	23.0	11.0	7.0	26.0	5.000
SO 00021-10-3/8	246.0210.280	100	17	21.0	9.0	6.0	21.0	3.000
SO 00021-10-1/2	246.0210.285	100	19	24.0	11.0	7.0	26.0	5.000
SO 00021-12-1/2	246.0210.400	100	19	26.0	11.0	7.0	26.0	5.000
SO 00021-14-1/2	246.0210.504	64	22	28.0	11.0	8.0	26.0	6.000
SO 00021-15-1/2	246.0210.534	64	22	28.0	11.0	8.0	26.0	6.000
SO 00021-15-3/4	246.0210.536	64	27	30.0	12.0	9.0	32.0	10.150
Für Zollrohre	Pour tubes pouces			For inch tubes				
SO 00021-6,35-1/8	246.0210.135	125	12	16.5	8.0	6.0	12.0	0.938
SO 00021-6,35-1/4	246.0210.140	125	14	18.0	8.0	6.0	17.0	2.000
SO 00021-7,94-1/4	246.0210.168	125	14	19.0	8.0	6.0	17.0	2.000
SO 00021-9,52-3/8	246.0210.235	100	17	21.0	9.0	6.0	21.0	3.000
SO 00021-12,7-1/2	246.0210.434	100	22	32.0	11.0	8.0	26.0	6.000

d=Rohraussen-ø
 dr= Grösse der Anschlussmutter
 L= Mass in montiertem Zustand

d=ø extérieur du tube
 dr= dimension de l'écrou de base
 L=après montage

d=tube outside diameter
 dr=size of the connection nut
 L=installed length

Manometeranschluss

Ecrou de manomètre

Pressure gauge connection

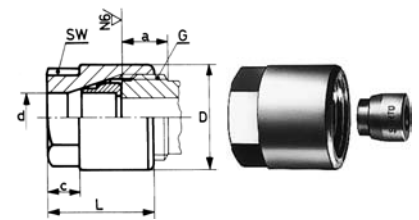

SO 00021 MAN

Type -d-G	Mat.-Nr.	bar	SW	L	a	c	D	kg/100
G=Rohrgewinde (zylindrisch)								
			G=Filetage-gaz BSP (cylindrique)					
						G=BSP thread (straight)		
SO 00021-6-¼ MAN	246.0211.110	125	14	20.0	9.0	6.0	17.0	2.200
SO 00021-6-½ MAN	246.0211.125	125	22	25.5	11.0	8.0	26.0	6.700
SO 00021-8-¼ MAN	246.0211.170	125	14	19.0	8.0	6.0	17.0	2.000
SO 00021-8-½ MAN	246.0211.185	125	22	26.0	11.0	8.0	26.0	6.750
SO 00021-10-½ MAN	246.0211.285	100	19	24.0	11.0	7.0	26.0	5.400
SO 00021-12-½ MAN	246.0211.400	100	19	26.0	11.0	7.0	26.0	5.860

Anwendungsbeispiele:

Exemples d'utilisation:

Sample combinations:

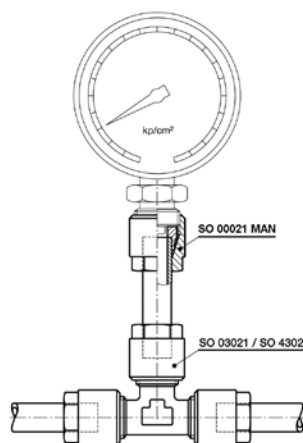

4G

d=Rohrassen-ø
 dr= Grösse der Anschlussmutter
 L= Mass in montiertem Zustand

d=ø extérieur du tube
 dr= dimension de bécrou de base
 L=après montage

d=tube outside diameter
 dr=size of the connection nut
 L=installed length

Übergangsmuffe

Adaptateur femelle

Female adaptor

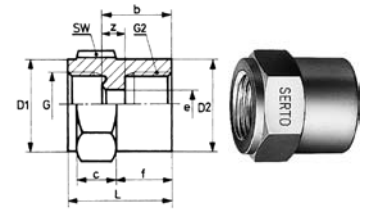
SO 00030

Type -G -G2	Mat.-Nr.	bar	SW	L	b	c	D1	D2	f	z	e	kg/100
G=Rohrgewinde (zylindrisch)	G=Filetage-gaz BSP (cylindrique)	G=BSP thread (straight)										
G2=Rohrgewinde (zylindrisch)	G2=Filetage-gaz BSP (cylindrique)	G2=BSP thread (straight)										
SO 00030-1/8-1/8	246.0301.042	125	14	22.0	14.5	8.0	14.0	14.0	12.0	4.5	4.0	1.850
SO 00030-1/8-1/4	246.0301.044	125	19	23.5	16.0	9.0	18.8	18.8	12.5	5.0	4.0	4.100
SO 00030-1/8-3/8	246.0301.046	125	22	25.0	17.5	10.0	22.0	22.0	13.0	5.5	4.0	5.700
SO 00030-1/8-1/2	246.0301.048	125	27	27.5	20.0	12.0	27.0	27.0	13.5	6.0	4.0	9.600
SO 00030-1/4-1/8	246.0301.102	125	17	22.5	14.5	8.0	17.0	15.0	11.5	4.5	6.0	2.450
SO 00030-1/4-1/4	246.0301.104	125	19	24.0	16.0	9.0	18.8	18.8	13.0	5.0	6.0	3.750
SO 00030-1/4-3/8	246.0301.106	125	22	25.5	17.5	10.0	22.0	22.0	13.5	5.5	6.0	5.350
SO 00030-1/4-1/2	246.0301.108	125	27	28.0	20.0	12.0	27.0	27.0	14.0	6.0	6.0	9.450
SO 00030-3/8-1/4	246.0301.164	100	22	24.5	16.0	10.0	21.8	20.0	10.5	5.0	8.0	4.750
SO 00030-3/8-3/8	246.0301.166	100	24	26.0	17.5	10.0	23.8	23.8	14.0	5.5	8.0	4.650
SO 00030-3/8-1/2	246.0301.168	100	30	28.5	20.0	12.0	29.8	29.8	14.5	6.0	8.0	12.000
SO 00030-1/2-1/4	246.0301.224	100	27	26.5	16.0	12.0	26.0	20.0	10.5	5.0	8.4	6.700
SO 00030-1/2-3/8	246.0301.226	100	27	28.0	17.5	12.0	26.8	25.0	12.0	5.5	10.0	7.850
SO 00030-1/2-1/2	246.0301.228	100	30	30.5	20.0	12.0	29.8	29.8	16.5	6.0	12.0	11.600
SO 00030-1/2-3/4	246.0301.232	100	32	34.0	23.5	12.0	32.0	32.0	18.0	6.5	12.0	12.750

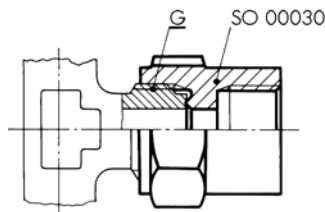
Anwendungsbeispiele:
Exemples d'utilisation:
Sample combinations:

Die Übergangsmuffe SO 00030 kann an jedes SERTO-Formteil mit dem passenden zylindrischen Gewinde G aufgeschraubt werden.

L'adaptateur femelle SO 00030 peut être monté sur toutes les pièces de forme SERTO avec le filetage cylindrique G correspondant.

The female adaptor SO 00030 can be screwed onto any SERTO-union body with the relevant straight thread G.

Dichtungsprinzip:

Bei der Montage drückt sich der Wulst des Übergangsstückes in das SERTO-Formteil ein, dadurch entsteht eine einwandfreie metallische Dichtung.

Principe d'étanchéité:

Lors du serrage, le bourrelet s'enfonce dans la pièce de forme SERTO et donne un joint métallique parfait.

Sealing principle:

On being installed, the lip of the adaptor presses into the SERTO-union body, forming a sound metallic seal.

Wir empfehlen, das Gewinde mit einem geeigneten Flüssigklebstoff gegen unbeabsichtigtes Lösen zu sichern.

Nous recommandons de bloquer le filetage avec une colle appropriée contre un desserrage intempestif.

We recommend to secure the thread with a suitable cement against unintended loosening.

Achtung:

Bei der Bestellung bitte nicht G und G1 verwechseln. Siehe Montagebeispiele SO 02221, SO 03221, SO 04221, SO 05221.

Attention:

Lors de la commande ne pas confondre les filetages G et G1. Exemples de montage SO 02221, SO 03221, SO 04221, SO 05221.

Caution:

Please do not confuse G and G1 when ordering. See combination examples SO 02221, SO 03221, SO 04221, SO 05221.

Übergangsmuffe NPT

Adaptateur femelle NPT

Female adaptor NPT

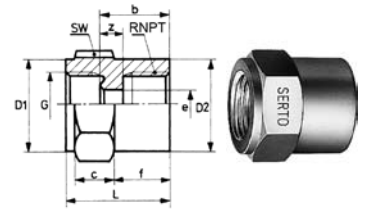

SO 00030 NPT

Type -G -RNPT	Mat.-Nr.	bar	SW	L	b	c	D1	D2	f	z	e	kg/100
G=Rohrgewinde (zylindrisch)	G=Filetage-gaz BSP (cylindrique)	G=BSP thread (straight)										
RNPT=NPT Gewinde	RNPT=Filetage NPT	RNPT=NPT thread										
SO 00030-1/8-1/8 NPT	246.0302.042	125	14	22.0	14.5	8.0	14.0	14.0	12.0	5.0	4.0	1.900
SO 00030-1/8-1/4 NPT	246.0302.044	125	19	26.5	19.0	9.0	18.8	19.0	15.5	5.0	4.0	4.200
SO 00030-1/4-1/8 NPT	246.0302.102	125	17	22.5	14.5	8.0	17.0	15.0	11.5	5.0	6.0	2.650
SO 00030-1/4-1/4 NPT	246.0302.104	125	19	27.0	19.0	9.0	18.8	19.0	16.0	5.0	6.0	4.250
SO 00030-3/8-1/4 NPT	246.0302.164	100	22	27.5	14.0	10.0	21.8	20.0	13.5	5.0	8.0	5.300
SO 00030-3/8-3/8 NPT	246.0302.166	100	22	27.5	19.0	10.0	21.8	22.0	15.5	5.0	8.0	5.100
SO 00030-1/2-3/8 NPT	246.0302.226	100	30	30.0	19.5	12.0	29.8	22.0	16.0	6.0	10.0	8.700
SO 00030-1/2-1/2 NPT	246.0302.228	100	30	34.0	23.5	12.0	29.6	30.0	20.0	6.0	12.0	12.800

Anwendungsbeispiele:

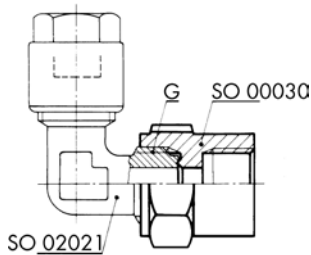

Die Übergangsmuffe SO 00030 kann an jedes SERTO-Formteil mit dem passenden zylindrischen Gewinde G aufgeschraubt werden.

Dichtungsprinzip:

Bei der Montage drückt sich der Wulst des Übergangsstückes in das SERTO-Formteil ein, dadurch entsteht eine einwandfreie metallische Dichtung.

Wir empfehlen, das Gewinde mit einem geeigneten Flüssigklebstoff gegen unbeabsichtigtes Lösen zu sichern.

Achtung:

Bei der Bestellung bitte nicht G und G1 verwechseln. Siehe Montagebeispiele SO 02221, SO 03221, SO 04221, SO 05221.

Exemples d'utilisation:

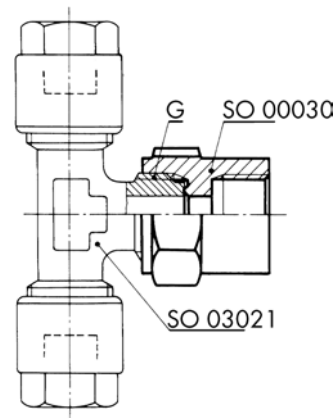

L'adaptateur femelle SO 00030 peut être monté sur toutes les pièces de forme SERTO avec le filetage cylindrique G correspondant.

Principe d'étanchéité:

Lors du serrage, le bourrelet s'enfonce dans la pièce de forme SERTO et donne un joint métallique parfait.

Nous recommandons de bloquer le filetage avec une colle appropriée contre un desserrage intempestif.

Attention:

Lors de la commande ne pas confondre les filetages G et G1. Exemples de montage SO 02221, SO 03221, SO 04221, SO 05221.

Sample combinations:

The female adaptor SO 00030 can be screwed onto any SERTO-union body with the relevant straight thread G.

Sealing principle:

On being installed, the lip of the adaptor presses into the SERTO-union body, forming a sound metallic seal.

We recommend to secure the thread with a suitable cement against unintended loosening.

Caution:

Please do not confuse G and G1 when ordering. See combination examples SO 02221, SO 03221, SO 04221, SO 05221.

Übergangsnippel NPT
Adaptateur mâle NPT
Male adaptor NPT

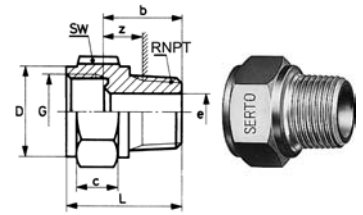

SO 00040 NPT

Type -G -RNPT	Mat.-Nr.	bar	SW	L	b	c	D	z	e	kg/100
G=Rohrgewinde (zylindrisch)	G=Filetage-gaz BSP (cylindrique)		G=BSP thread (straight)							
RNPT=NPT Gewinde	RNPT=Filetage NPT		RNPT=NPT thread							
SO 00040-1/8-1/8 NPT	246.0402.042	125	14	20.0	12.5	7.0	13.0	6.0	4.0	1.400
SO 00040-1/8-1/4 NPT	246.0402.044	125	14	24.0	16.5	7.0	13.0	6.5	4.0	2.200
SO 00040-1/4-1/8 NPT	246.0402.102	125	17	22.0	14.0	9.0	17.0	7.5	6.0	1.900
SO 00040-1/4-1/4 NPT	246.0402.104	125	17	27.0	19.0	9.0	17.0	9.0	6.0	2.750
SO 00040-1/4-3/8 NPT	246.0402.106	125	17	27.0	19.0	9.0	17.0	9.0	6.0	3.100
SO 00040-3/8-1/4 NPT	246.0402.164	100	22	29.0	20.5	10.0	21.0	10.5	8.0	3.900
SO 00040-3/8-3/8 NPT	246.0402.166	100	22	29.0	20.5	10.0	21.0	10.0	8.0	4.600
SO 00040-1/2-3/8 NPT	246.0402.226	100	27	31.0	20.5	12.0	26.0	10.0	10.0	6.600
SO 00040-1/2-1/2 NPT	246.0402.228	100	27	35.0	24.5	12.0	26.0	11.0	12.0	7.500

Übergangsnippel METR
Pièce intermédiaire mâle METR
Male adapter METR

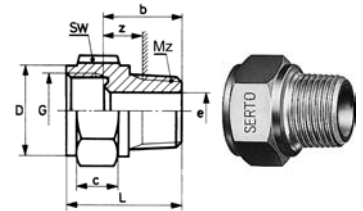

4G

SO 00040 METR

Type -G -Mk	Mat.-Nr.	bar	SW	L	b	c	D	z	e	kg/100
G=Rohrgewinde (zylindrisch)	G=Filetage-gaz BSP (cylindrique)		G=BSP thread (straight)							
Mk=metrisches Gewinde (kegelig)	Mk=Filetage métrique (conique)		Mk=Metric thread (tapered)							
SO 00040-1/8-M10x1 K	246.0403.040	125	14	18.0	10.5	7.0	13.0	5.0	5.0	1.150
SO 00040-1/4-M12x1,5 K	246.0403.085	125	17	24.0	16.0	9.0	17.0	7.5	6.0	2.200
SO 00040-3/8-M14x1,5 K	246.0403.125	100	22	26.0	17.5	10.0	21.0	9.0	8.0	3.800
SO 00040-1/2-M16x1,5 K	246.0403.165	100	27	28.0	17.5	12.0	26.0	9.0	10.0	1.400

Fortsetzung nächste Seite

Suite à la prochaine page

Continued on next page

d=Rohraussen-ø
 e= kleinste Bohrung
 L= Mass in montiertem Zustand

d=ø extérieur du tube
 e= ø-min. de passage
 L=après montage

d=tube outside diameter
 e=minimum bore
 L=installed length

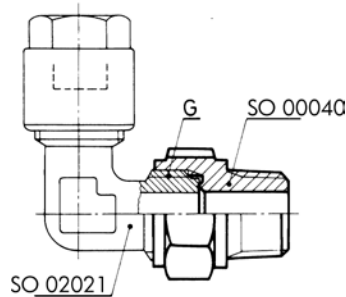
Anwendungsbeispiele:

Der Übergangsnippel SO 00040 kann an jedes SERTO-Formteil mit dem passenden zylindrischen Gewinde G aufgeschraubt werden.

Dichtungsprinzip:

Bei der Montage drückt sich der Wulst des Übergangsstückes in das SERTO-Formteil ein, dadurch entsteht eine einwandfreie metallische Dichtung. Wir empfehlen, das Gewinde mit einem geeigneten Flüssigklebstoff gegen unbeabsichtigtes Lösen zu sichern.

Achtung:

Bei der Bestellung bitte nicht G und R verwechseln. Siehe Montagebeispiele SO 02121, SO 03121, SO 04121, SO 05121.

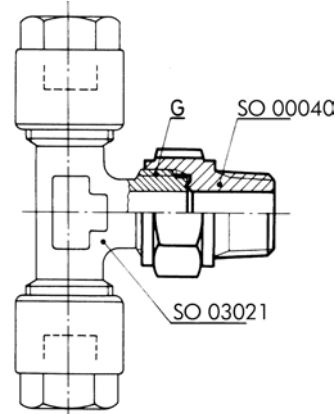
Exemples d'utilisation:

L'adaptateur mâle SO 00040 peut être monté sur toutes les pièces de forme SERTO avec le filetage cylindrique G correspondant.

Principe d'étanchéité:

Lors du serrage, le bourrelet s'enfonce dans la pièce de forme SERTO et donne un joint métallique parfait. Nous recommandons de freiner le filetage avec une résine appropriée contre un desserrage intempestif.

Attention:

Lors de la commande ne pas confondre les filetages G et R. Exemples de montage SO 02121, SO 03121, SO 04121, SO 05121.

Sample combinations:

The male adaptor SO 00040 can be screwed onto any SERTO-union body with the relevant straight thread G.

Sealing principle:

On being installed, the lip of the adaptor presses into the SERTO-union body, forming a sound metallic seal. We recommend to secure the thread with a suitable cement against unintended loosening.

Caution:

Please do not confuse G and R when ordering. See combination examples SO 02121, SO 03121, SO 04121, SO 05121.

Anschlussnippel METR

Ecrou de raccordement mâle METR

Nipple connection METR

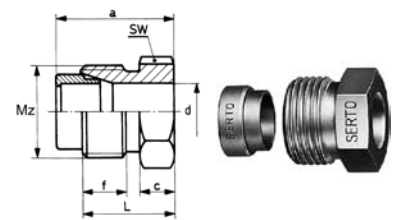
SO 01001 METR

Type -d-Mz	Mat.-Nr.	bar	SW	L	a	b	c	f	t	kg/100
Für metrische Rohre	Pour tubes métriques	For metric tubes								
Mz=metrisches Gewinde (zylindrisch)	Mz=Filetage métrique (cylindrique)	Mz=Metric thread (straight)								
SO 01001-4-M8x0,75	246.1003.088	125	8	10,5	13,5	6,0	4,0	5,0	6,5	0,330
SO 01001-6-M11x0,75	246.1003.183	100	12	13,5	17,5	8,5	5,5	6,0	9,5	0,860
Für Zollrohre	Pour tubes pouces	For inch tubes								
SO 01001-6,35-M11x0,75	246.1003.215	100	12	13,5	18,0	9,0	5,5	8,0	10,0	0,820

Fortsetzung nächste Seite

Suite à la prochaine page

Continued on next page

d=Rohrussen-ø
e= kleinste Bohrung
L= Mass in montiertem Zustand

d=ø extérieur du tube
e= ø-min. de passage
L=après montage

d=tube outside diameter
e=minimum bore
L=installed length

Anschlussnippel

Ecrou de raccordement mâle

Nipple connection

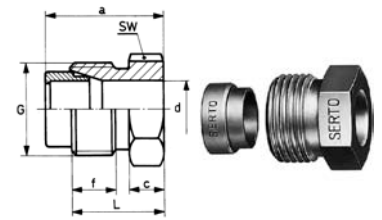

SO 01001

Type -d-G	Mat.-Nr.	bar	SW	L	a	b	c	f	t	kg/100
Für metrische Rohre G=Rohrgewinde (zylindrisch)	Pour tubes métriques G=Filetage-gaz BSP (cylindrique)	For metric tubes G=BSP thread (straight)								
SO 41001-4-1/8	016.1001.060	125	10	12.0	14.5	6.0	4.0	6.0	6.5	0.650
SO 41001-5-1/8	016.1001.082	125	10	12.0	14.5	6.0	4.0	6.0	6.5	0.550
SO 41001-6-1/4	016.1001.110	250	14	16.0	19.0	8.5	6.0	7.5	9.5	1.450
SO 01001-8-1/4	246.1001.170	125	14	16.0	20.0	8.5	6.0	7.5	9.5	1.200
SO 01001-10-3/8	246.1001.280	100	17	17.0	21.0	9.0	6.5	8.0	10.0	2.000
SO 01001-12-1/2	246.1001.400	100	19	19.0	22.0	9.5	7.0	9.0	10.5	2.950
SO 01001-14-1/2	246.1001.504	64	22	20.5	28.0	13.0	8.0	9.5	14.0	3.700
SO 01001-15-3/4	246.1001.536	64	27	22.0	25.5	10.0	9.0	10.0	11.0	6.750
Für Zollrohre G=Rohrgewinde (zylindrisch)	Pour tubes pouces G=Filetage-gaz BSP (cylindrique)	For inch tubes G=BSP thread (straight)								
SO 41001-6,35-1/4	016.1001.140	100	14	16.0	18.5	8.5	6.0	7.5	9.5	1.420
SO 01001-9,52-3/8	246.1001.235	100	17	17.0	21.5	8.5	6.5	8.0	9.5	2.094
SO 01001-12,7-1/2	246.1001.434	100	22	20.0	24.5	10.0	8.0	9.0	11.0	3.210

4G

Anwendungsbeispiele:	Exemples d'utilisation:	Sample combinations:
<p>Nippel SO 01000 mit Klemmring SO 00001 oder Nippel SO 41000 mit Klemmring SO 40001. Die entsprechende Kupferdichtung SO 40005 ist immer separat zu bestellen. Weitere Einschraubgewinde auf Anfrage.</p>	<p>Ecrou mâle SO 01000 avec bague de serrage SO 00001 ou écrou mâle SO 41000 avec bague de serrage SO 40001. Les joints correspondants SO 40005 sont à commander séparément. Autres filetages sur demande.</p>	<p>Nipple SO 01000 with compression ferrule SO 00001 or nipple SO 41000 with compression ferrule SO 40001. The relevant copper washer SO 40005 must always be ordered separately. Other threads on request</p>

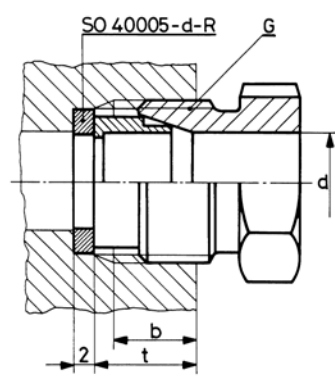

d=Rohraussen-ø
G=Gewindeanschluss am Manometer

d=ø extérieur du tube
G=Filetage de raccordement au manomètre

d=tube outside diameter
G=Thread connection on pressure gauge

Gerade Verschraubung
Union double
Straight union

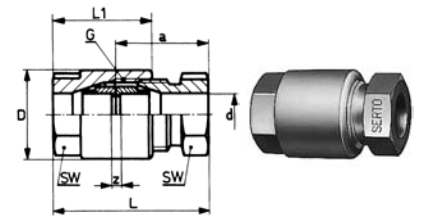

SO 01011

Type -d	Mat.-Nr.	bar	SW	G1	L	L1	a	D	z	kg/100
Für metrische Rohre	Pour tubes métriques			For metric tubes						
SO 01011-4	248.1010.040	125	8	M8x0.75	22.5	15.0	13.5	10.0	2.0	0.860
SO 01011-5	248.1010.050	125	10	1/8	25.5	17.0	15.5	12.0	2.0	1.450
SO 01011-6	248.1010.060	125	12	M11x0.75	28.5	17.5	17.5	14.0	2.4	2.050
SO 01011-8	248.1010.080	125	14	1/4	32.5	21.5	20.0	17.0	2.0	3.450
SO 01011-10	248.1010.100	100	17	3/8	36.0	23.5	21.0	21.0	2.0	5.450
SO 01011-12	248.1010.120	100	19	1/2	40.0	26.0	22.5	26.0	2.4	8.600
SO 01011-14	248.1010.140	64	22	1/2	48.5	33.0	28.0	26.0	3.0	11.100
SO 01011-15	248.1010.150	64	27	3/4	46.0	30.0	25.5	32.0	3.0	16.850
Für Zollrohre	Pour tubes pouces			For inch tubes						
SO 01011-6,35	248.1010.063	125	12	M11x0.75	25.0	17.5	15.5	14.0	2.0	2.050
SO 01011-9,52	248.1010.095	100	17	3/8	36.5	24.0	21.3	21.0	2.0	5.450
SO 01011-12,7	248.1010.127	100	22	1/2	43.0	28.0	24.5	26.0	2.4	8.600

Die Mutter der geraden Verschraubung SO 01011 darf nicht mit dem Armaturenanschluss SO 00021 ausgetauscht werden. Für das Verbinden von Rohren verschiedener Qualitäten bzw. Werkstoffe ist die Gerade Verschraubung SO 01021 zu verwenden.

L'écrou femelle de l'union double SO 01011 ne doit pas être échangé contre l'écrou SO 00021. Pour le raccordement des tubes de qualités différentes, utiliser l'union double SO 01021.

The nut of the straight union SO 01011 must not be exchanged with the nut connection SO 00021. To connect tubes of differing quality or materials, use the straight union SO 01021.

d=Rohrassen-ø
 e= kleinste Bohrung
 L= Mass in montiertem Zustand
 s= Wandstärke

d= ø extérieur du tube
 e= ø-min. de passage
 L=après montage
 s=épaisseur de la paroi

d=tube outside diameter
 e=minimum bore
 L=installed length
 s=wall thickness

Gerade Verschraubung
Union double
Straight union

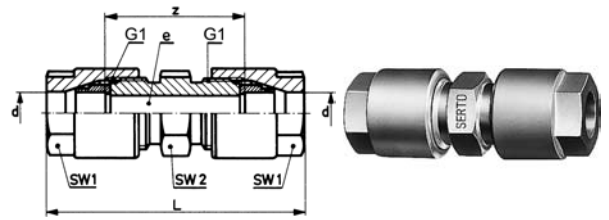

SO 01021

Type -d	Mat.-Nr.	bar	G1	SW1	SW2	L	z	e	kg/100
Für metrische Rohre	Pour tubes métriques		For metric tubes						
SO 01021-4	248.1020.040	125	1/8	12	12	42.0	28.0	4.5	3.250
SO 01021-5	248.1020.050	125	1/8	12	12	44.0	28.0	4.5	3.250
SO 01021-6	248.1020.060	125	1/8	12	12	44.0	28.0	4.5	3.300
SO 01021-8	248.1020.080	125	1/4	14	14	51.0	30.0	6.5	6.150
SO 01021-10	248.1020.100	100	3/8	17	17	57.0	32.0	8.5	10.400
SO 01021-12	248.1020.120	100	1/2	22	22	68.0	38.5	12.0	17.750
SO 01021-14	248.1020.140	64	1/2	22	22	72.0	39.0	12.0	19.150
SO 01021-15	248.1020.150	64	1/2	22	22	72.0	39.0	12.0	19.000
Für Zollrohre	Pour tubes pouces		For inch tubes						
SO 01021-6,35	248.1020.063	125	1/8	12	12	44.0	28.0	4.5	3.300
SO 01021-9,52	248.1020.095	100	3/8	17	17	57.0	32.0	8.5	10.400

Gerade Verschraubung reduziert
Union double réduite
Straight reduction union

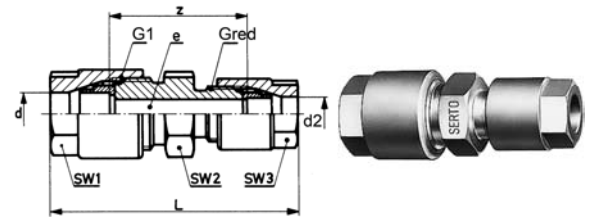

SO 01021 RED

Type -d -d2	Mat.-Nr.	bar	G1	G red	SW1	SW2	SW3	L	z	e	kg/100
Für metrische Rohre	Pour tubes métriques		For metric tubes								
SO 01021-6-4	248.1024.110	125	1/8	1/8	12	12	12	43.0	28.0	4.5	3.300
SO 01021-8-6	248.1024.140	125	1/4	1/8	14	14	12	47.5	29.0	4.5	5.100
SO 01021-10-8	248.1024.190	100	3/8	1/4	17	17	14	54.5	31.5	6.5	8.750
SO 01021-12-8	248.1024.225	100	1/2	1/4	19	22	14	60.0	35.0	6.5	10.150
SO 01021-12-10	248.1024.240	100	1/2	3/8	19	22	17	63.0	35.5	8.5	15.150
SO 01021-14-8	248.1024.300	64	1/2	1/4	22	22	14	62.0	35.0	6.5	16.100
SO 01021-14-12	248.1024.340	64	1/2	1/2	22	22	19	70.0	39.0	12.0	18.150
SO 01021-15-8	248.1024.400	64	1/2	1/4	22	22	14	62.0	35.5	6.5	13.750
SO 01021-15-10	248.1024.410	64	1/2	1/2	22	22	19	68.0	38.5	12.0	15.900
SO 01021-15-12	248.1024.420	64	1/2	1/2	22	22	19	70.0	39.0	12.0	18.250
Für Zollrohre	Pour tubes pouces		For inch tubes								
SO 01021-6,35-4	248.1024.123	125	1/8	1/8	12	12	12	43.0	28.0	4.5	3.300
SO 01021-6,35-5	248.1024.126	125	1/8	1/8	12	12	12	43.0	28.0	4.5	3.300
SO 01021-6,35-6	248.1024.128	125	1/8	1/8	12	12	12	43.0	28.0	4.5	3.300
SO 01021-10,9,52	248.1024.197	100	3/8	3/8	17	17	17	54.5	31.5	8.5	8.750

d=Rohrassen-ø
e= kleinste Bohrung
L= Mass in montiertem Zustand
s= Wandstärke

d= ø extérieur du tube
e= ø-min. de passage
L=après montage
s=épaisseur de la paroi

d=tube outside diameter
e=minimum bore
L=installed length
s=wall thickness

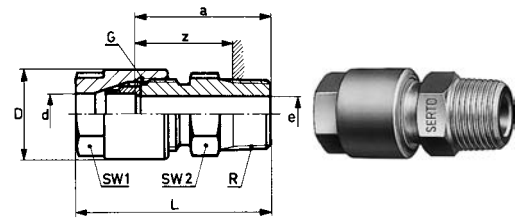
Gerade Einschraubverschraubung
Union mâle
Male adaptor union

SO 01121

Type -d-R	Mat.-Nr.	bar	G1	SW1	SW2	L	a	D	z	e	kg/100	
Für metrische Rohre	Pour tubes métriques					For metric tubes						
R=Rohrgewinde (kegelig)	R=Filetage-gaz BSP (conique)					R=BSP thread (tapered)						
SO 01121-4-1/8	248.1101.060	125	1/8	12	10	30.0	23.0	10.0	18.5	4.0	2.250	
SO 01121-4-1/4	248.1101.065	125	1/8	12	14	37.0	30.0	12.0	20.0	4.0	3.000	
SO 01121-5-1/8	248.1101.082	125	1/8	12	10	30.0	23.0	12.0	18.5	4.0	2.300	
SO 01121-5-1/4	248.1101.084	125	1/8	12	14	38.0	30.0	12.0	20.0	4.0	3.000	
SO 01121-6-1/8	248.1101.100	125	1/8	12	10	30.0	23.0	12.0	18.5	4.0	2.300	
SO 01121-6-1/4	248.1101.110	125	1/8	12	14	38.0	30.0	12.0	20.0	4.0	3.000	
SO 01121-6-3/8	248.1101.120	125	1/8	12	17	38.0	30.0	12.0	20.0	4.0	3.700	
SO 01121-8-1/8	248.1101.160	125	1/4	14	14	37.5	27.0	17.0	20.5	5.0	4.000	
SO 01121-8-1/4	248.1101.170	125	1/4	14	14	41.5	31.0	17.0	21.0	6.4	4.350	
SO 01121-8-3/8	248.1101.180	125	1/4	14	17	41.5	31.0	17.0	21.0	6.4	5.000	
SO 01121-8-1/2	248.1101.185	125	1/4	14	22	44.5	34.0	17.0	21.0	6.4	6.850	
SO 01121-10-1/4	248.1101.270	100	3/8	17	17	44.0	31.5	21.0	21.5	8.4	6.350	
SO 01121-10-3/8	248.1101.280	100	3/8	17	17	44.0	31.5	21.0	21.5	8.4	7.000	
SO 01121-10-1/2	248.1101.285	100	3/8	17	22	47.0	34.5	21.0	21.0	8.4	8.600	
SO 01121-12-1/4	248.1101.380	100	1/2	19	22	50.0	35.5	26.0	25.5	8.0	11.600	
SO 01121-12-1/2	248.1101.400	100	1/2	19	22	52.0	37.5	26.0	24.5	12.0	11.700	
SO 01121-12-3/8	248.1101.390	100	1/2	19	22	50.0	35.5	26.0	25.5	10.0	11.200	
SO 01121-12-3/4	248.1101.405	100	1/2	19	27	55.0	40.5	26.0	26.0	12.0	15.000	
SO 01121-14-3/8	248.1101.502	64	1/2	22	22	52.0	35.5	26.0	25.5	10.0	11.200	
SO 01121-14-1/2	248.1101.504	64	1/2	22	22	54.0	37.5	26.0	24.5	12.0	11.700	
SO 01121-14-3/4	248.1101.506	64	1/2	22	27	57.0	40.5	26.0	26.0	12.0	15.000	
SO 01121-15-3/8	248.1101.532	64	1/2	22	22	52.0	35.5	26.5	25.5	10.0	12.250	
SO 01121-15-1/2	248.1101.534	64	1/2	22	22	54.0	37.5	26.5	24.5	12.0	12.650	
SO 01121-15-3/4	248.1101.536	64	1/2	22	27	57.0	40.5	26.5	26.0	12.0	15.450	
Für Zollrohre	Pour tubes pouces					For inch tubes						
SO 01121-6,35-1/8	248.1101.135	125	1/8	12	12	33.0	25.0	12.0	18.5	4.0	2.270	
SO 01121-6,35-1/4	248.1101.140	125	1/8	12	14	38.0	30.0	12.0	20.0	4.0	2.970	
SO 01121-6,35-3/8	248.1101.145	125	1/8	12	17	38.0	30.0	12.0	20.0	4.0	3.670	
SO 01121-9,52-1/4	248.1101.230	100	3/8	17	17	44.0	31.5	21.0	21.5	8.4	6.500	
SO 01121-9,52-3/8	248.1101.235	100	3/8	17	17	44.0	31.5	21.0	21.5	8.4	7.150	
SO 01121-9,52-1/2	248.1101.240	100	3/8	17	22	47.0	34.5	21.0	21.0	8.4	8.750	
SO 01121-12,7-1/4	248.1101.430	100	1/2	19	22	50.0	35.5	26.0	25.5	8.0	12.400	
SO 01121-12,7-3/8	248.1101.432	100	1/2	19	22	50.0	35.5	26.0	25.5	10.0	12.000	
SO 01121-12,7-1/2	248.1101.434	100	1/2	19	22	52.0	37.5	26.0	24.5	12.0	12.500	
SO 01121-12,7-3/4	248.1101.436	100	1/2	19	27	55.0	40.5	26.0	26.0	12.0	15.800	

d=Rohrassen-ø
e= kleinste Bohrung
L= Mass in montiertem Zustand

d=ø extérieur du tube
e= ø-min. de passage
L=après montage

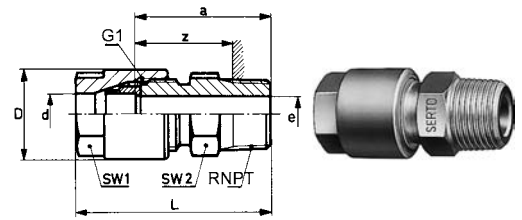
d=tube outside diameter
e=minimum bore
L=installed length

Gerade Einschraubverschraubung NPT
Union mâle NPT
Male adaptor union NPT

SO 01121 NPT

Type -d -RNPT	Mat.-Nr.	bar	G1	SW1	SW2	L	a	D	z	e	kg/100	
Für metrische Rohre	Pour tubes métriques			For metric tubes								
RNPT=NPT Gewinde	RNPT=Filetage NPT			RNPT=NPT thread								
SO 01121-4-1/8 NPT	248.1102.060	125	1/8	12	12	34.0	27.0	12.0	20.5	4.0	2.400	
SO 01121-4-1/4 NPT	248.1102.065	125	1/8	12	14	40.0	33.0	12.0	23.0	4.0	3.250	
SO 01121-5-1/8 NPT	248.1102.082	125	1/8	12	12	41.0	27.0	12.0	20.5	4.0	2.400	
SO 01121-5-1/4 NPT	248.1102.084	125	1/8	12	14	41.0	33.0	12.0	23.0	4.0	3.250	
SO 01121-6-1/8 NPT	248.1102.100	125	1/8	12	12	35.0	27.0	12.0	20.5	4.0	2.450	
SO 01121-6-1/4 NPT	248.1102.110	125	1/8	12	14	41.0	33.0	12.0	23.0	4.0	3.300	
SO 01121-8-1/8 NPT	248.1102.160	125	1/4	14	14	39.5	29.0	17.0	22.5	6.4	3.850	
SO 01121-8-1/4 NPT	248.1102.170	125	1/4	14	14	44.5	34.0	17.0	24.0	6.4	4.600	
SO 01121-8-3/8 NPT	248.1102.180	125	1/4	14	17	43.5	33.0	17.0	27.0	6.4	4.450	
SO 01121-10-1/4 NPT	248.1102.270	100	3/8	17	17	47.0	34.5	21.0	24.5	8.0	6.650	
SO 01121-10-3/8 NPT	248.1102.280	100	3/8	17	17	47.0	34.5	21.0	24.5	8.4	7.350	
SO 01121-10-1/2 NPT	248.1102.285	100	3/8	17	22	52.5	39.5	21.0	26.0	8.4	10.000	
SO 01121-12-3/8 NPT	248.1102.390	100	1/2	19	22	53.0	38.5	26.0	28.5	10.0	11.650	
SO 01121-12-1/2 NPT	248.1102.400	100	1/2	19	22	57.0	42.5	26.0	29.5	12.0	12.800	
SO 01121-14-3/8 NPT	248.1102.502	64	1/2	22	22	55.0	38.5	26.0	28.5	10.0	12.550	
SO 01121-14-1/2 NPT	248.1102.504	64	1/2	22	22	59.0	42.5	26.0	29.5	12.0	13.500	
SO 01121-15-3/8 NPT	248.1102.532	64	1/2	22	22	55.0	38.5	26.5	28.5	10.0	12.700	
SO 01121-15-1/2 NPT	248.1102.534	64	1/2	22	22	59.0	42.5	26.5	29.5	12.0	13.700	
Für Zollrohre	Pour tubes pouces			For inch tubes								
SO 01121-6,35-1/8 NPT	248.1102.135	125	1/8	12	12	35.0	27.0	12.0	20.5	4.0	2.420	
SO 01121-6,35-1/4 NPT	248.1102.140	125	1/8	12	14	41.0	33.0	12.0	23.0	4.0	3.270	
SO 01121-9,52-1/4 NPT	248.1102.230	100	3/8	17	17	47.0	34.5	21.0	24.5	8.0	6.800	
SO 01121-9,52-3/8 NPT	248.1102.235	100	3/8	17	17	47.0	34.5	21.0	24.5	8.4	7.500	
SO 01121-9,52-1/2 NPT	248.1102.240	100	1/2	17	22	52.5	39.5	21.0	26.0	8.4	10.150	
SO 01121-12,7-3/8 NPT	248.1102.432	100	1/2	22	22	53.0	38.5	26.0	28.5	10.0	12.450	
SO 01121-12,7-1/2 NPT	248.1102.434	100	1/2	22	22	57.0	42.5	26.0	29.5	12.0	13.600	

4G

d=Rohrøussen-ø
e= kleinste Bohrung
L= Mass in montiertem Zustand

d=ø extérieur du tube
e= ø-min. de passage
L=après montage

d=tube outside diameter
e=minimum bore
L=installed length

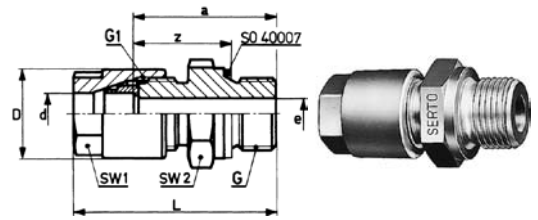
Gerade Einschraubverschraubung
Union mâle
Male adaptor union

SO 01124

Type -d-G	Mat.-Nr.	bar	G1	SW1	SW2	L	a	D	z	e	kg/100
Für metrische Rohre	Pour tubes métriques		For metric tubes								
G=Rohrgewinde (zylindrisch)	G=Filetage-gaz BSP (cylindrique)		G=BSP thread (straight)								
SO 01124-4-1/8	248.1141.060	125	1/8	12	14	31.5	24.5	12.0	16.0	4.0	2.400
SO 01124-5-1/8	248.1141.082	125	1/8	12	14	32.5	24.5	12.0	16.0	4.0	2.400
SO 01124-6-1/8	248.1141.100	125	1/8	12	14	32.5	24.5	12.0	16.0	4.0	2.400
SO 01124-6-1/4	248.1141.110	125	1/8	12	19	38.0	30.0	12.0	19.5	4.0	4.050
SO 01124-8-1/8	248.1141.160	125	1/4	14	14	36.0	25.5	17.0	17.5	5.0	3.860
SO 01124-8-1/4	248.1141.170	125	1/4	14	19	41.5	31.0	17.0	20.5	6.0	5.120
SO 01124-8-3/8	248.1141.180	125	1/4	14	22	43.0	32.5	17.0	22.0	6.0	6.950
SO 01124-10-1/4	248.1141.270	100	3/8	17	19	44.0	31.5	21.0	21.0	8.5	8.500
SO 01124-10-3/8	248.1141.280	100	3/8	17	22	45.5	33.0	21.0	22.5	8.5	8.800
SO 01124-12-1/4	248.1141.380	100	1/2	19	22	50.5	36.0	26.0	25.5	7.0	12.300
SO 01124-12-3/8	248.1141.390	100	1/2	19	22	50.5	36.0	26.0	25.5	9.0	12.100
SO 01124-12-1/2	248.1141.400	100	1/2	19	27	54.0	39.0	26.0	25.0	12.0	15.100
SO 01124-14-3/8	248.1141.502	64	1/2	22	22	52.5	36.0	26.0	25.5	9.0	12.700
SO 01124-14-1/2	248.1141.504	64	1/2	22	27	56.0	39.5	26.5	25.5	12.0	15.900
SO 01124-15-3/8	248.1141.532	64	1/2	22	22	52.5	36.0	26.5	25.5	9.0	12.850
SO 01124-15-1/2	248.1141.534	64	1/2	22	27	56.5	39.5	26.5	25.5	12.0	16.100
Für Zollrohre	Pour tubes pouces		For inch tubes								
SO 01124-6,35-1/8	248.1141.135	125	1/4	14	19	34.5	30.0	17.0	19.5	4.0	3.980
SO 01124-6,35-1/4	248.1141.140	125	1/8	12	14	39.0	24.5	12.0	17.5	4.0	2.380
SO 01124-9,52-1/4	248.1141.230	100	3/8	17	19	45.0	31.5	21.0	21.0	8.5	7.010
SO 01124-9,52-3/8	248.1141.235	100	3/8	17	22	45.5	33.0	21.0	22.5	8.5	8.910
SO 01124-12,7-3/8	248.1141.432	100	1/2	22	22	50.5	36.0	26.0	25.5	9.0	12.900

**Gerade Einschraubverschraubung
METR**

Union mâle METR

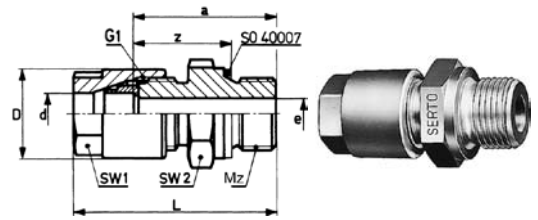
Male adaptor union METR



SO 01124 METR

Type -d -Mz	Mat.-Nr.	bar	G1	SW1	SW2	L	a	D	z	e	kg/100
Für metrische Rohre	Pour tubes métriques		For metric tubes								
Mz=metrisches Gewinde (zylindrisch)	Mz=Filetage métrique (cylindrique)		Mz=Metric thread (straight)								
SO 01124-4-M10x1	248.1143.096	125	1/8	12	14	32.0	24.5	12.0	17.5	4.0	2.500
SO 01124-5-M10x1	248.1143.135	125	1/8	12	14	32.5	24.5	12.0	17.5	4.0	2.450
SO 01124-6-M10x1	248.1143.180	125	1/8	12	14	32.5	24.5	12.0	17.5	4.0	2.400
SO 01124-8-M12x1,5	248.1143.240	125	1/4	14	17	41.5	31.0	17.0	20.0	6.0	4.550
SO 01124-8-M14x1,5	248.1143.245	125	1/4	14	19	41.5	31.0	17.0	20.0	6.0	5.350
SO 01124-10-M14x1,5	248.1143.280	100	3/8	17	19	44.0	31.5	21.0	21.0	7.0	7.080
SO 01124-12-M16x1,5	248.1143.330	100	1/2	19	22	50.0	35.5	26.0	25.0	9.0	11.750
SO 01124-12-M22x1,5	248.1143.338	100	1/2	19	27	54.0	39.5	26.0	27.0	10.0	14.350
SO 01124-14-M22x1,5	248.1143.385	64	1/2	22	27	56.0	39.5	26.0	27.0	10.0	15.050
SO 01124-15-M22x1,5	248.1143.395	64	1/2	22	27	56.0	40.5	26.5	28.0	10.0	15.200
Für Zollrohre	Pour tubes pouces		For inch tubes								
SO 01124-6,35-M10x1	248.1143.210	125	1/8	12	14	32.5	24.5	12.0	17.5	4.0	2.370
SO 01124-9,52-M14x1,5	248.1143.265	125	3/8	17	19	44.0	31.5	21.0	21.0	7.0	7.230
SO 01124-12,7-M16x1,5	248.1143.350	100	1/2	22	22	50.0	35.5	26.0	25.0	9.0	12.550
SO 01124-12,7-M22x1,5	248.1143.358	100	1/2	22	27	54.0	39.5	26.0	27.0	10.0	15.150



d=Rohrussen-ø
e= kleinste Bohrung
L= Mass in montiertem Zustand

d=ø extérieur du tube
e= ø-min. de passage
L=après montage

d=tube outside diameter
e=minimum bore
L=installed length

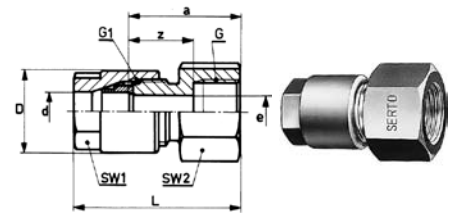
Gerade Aufschraubverschraubung
Union femelle
Female adaptor union

SO 01221

Type -d-G	Mat.-Nr.	bar	G1	SW1	SW2	L	a	D	z	e	kg/100
Für metrische Rohre	Pour tubes métriques					For metric tubes					
G=Rohrgewinde (zylindrisch)	G=Filetage-gaz BSP (cylindrique)					G=BSP thread (straight)					
SO 01221-4-1/8	248.1201.060	125	1/8	12	14	31.0	24.0	12.0	14.0	4.0	2.700
SO 01221-4-1/4	248.1201.065	125	1/8	12	17	32.5	25.5	12.0	14.5	4.0	3.250
SO 01221-5-1/8	248.1201.082	125	1/8	12	14	32.0	24.0	12.0	14.0	4.0	2.700
SO 01221-5-1/4	248.1201.084	125	1/8	12	17	33.5	25.5	12.0	14.5	4.0	3.250
SO 01221-6-1/8	248.1201.100	125	1/8	12	14	32.0	24.0	12.0	14.0	4.0	2.650
SO 01221-6-1/4	248.1201.110	125	1/8	12	17	33.5	25.5	12.0	14.5	4.0	3.300
SO 01221-6-3/8	248.1201.120	125	1/8	12	22	35.0	27.0	12.0	15.0	4.0	5.000
SO 01221-8-1/8	248.1201.160	125	1/4	14	14	35.5	25.0	17.0	15.0	6.0	4.000
SO 01221-8-1/4	248.1201.170	125	1/4	14	17	37.0	26.5	17.0	15.5	6.0	4.550
SO 01221-8-3/8	248.1201.180	125	1/4	14	22	38.5	28.0	17.0	16.0	6.4	6.250
SO 01221-8-1/2	248.1201.185	125	1/4	14	27	41.0	30.5	17.0	16.5	6.4	8.700
SO 01221-10-1/4	248.1201.270	100	3/8	17	17	39.5	27.0	21.0	16.0	8.4	6.250
SO 01221-10-3/8	248.1201.280	100	3/8	17	22	40.5	28.0	21.0	16.0	8.5	7.900
SO 01221-10-1/2	248.1201.285	100	3/8	17	27	43.5	31.0	21.0	17.0	8.5	10.400
SO 01221-10-3/4	248.1201.290	100	3/8	17	32	46.5	33.0	21.0	17.0	8.5	12.900
SO 01221-12-3/8	248.1201.390	100	1/2	19	22	46.0	31.0	26.0	19.0	10.0	11.150
SO 01221-12-1/2	248.1201.400	100	1/2	19	27	48.5	33.5	26.0	19.5	12.5	13.500
SO 01221-12-3/4	248.1201.405	100	1/2	19	32	51.5	36.5	26.0	19.5	12.5	15.800
SO 01221-14-3/8	248.1201.502	64	1/2	22	22	48.0	31.5	26.0	19.5	10.0	11.500
SO 01221-14-1/2	248.1201.504	64	1/2	22	27	50.5	34.0	26.0	20.0	12.5	14.300
SO 01221-14-3/4	248.1201.506	64	1/2	22	32	53.5	37.0	26.0	20.0	12.5	16.800
SO 01221-15-3/8	248.1201.532	64	1/2	22	22	48.0	31.5	26.5	19.5	10.0	11.900
SO 01221-15-1/2	248.1201.534	64	1/2	22	27	50.5	34.0	26.5	20.0	12.5	14.500
SO 01221-15-3/4	248.1201.536	64	1/2	22	32	53.5	37.0	26.5	20.0	12.5	17.000
Für Zollrohre	Pour tubes pouces					For inch tubes					
SO 01221-6,35-1/8	248.1201.135	125	1/8	12	14	32.0	24.0	12.0	14.0	4.0	2.620
SO 01221-6,35-1/4	248.1201.140	125	1/8	12	17	33.5	25.5	12.0	14.5	4.0	3.270
SO 01221-6,35-1/2	248.1201.150	125	1/4	14	27	41.0	30.5	17.0	16.5	6.4	8.900
SO 01221-9,52-1/4	248.1201.230	125	3/8	17	17	39.5	27.0	21.0	16.0	8.4	6.400
SO 01221-9,52-3/8	248.1201.235	125	3/8	17	22	40.5	28.0	21.0	16.0	8.5	8.050
SO 01221-9,52-1/2	248.1201.240	125	3/8	17	27	43.5	31.0	21.0	17.0	8.5	10.550
SO 01221-9,52-3/4	248.1201.244	125	3/8	17	32	46.5	33.0	21.0	17.0	8.5	13.050
SO 01221-12,7-3/8	248.1201.432	100	1/2	22	22	46.0	31.0	26.0	19.0	10.0	11.950
SO 01221-12,7-1/2	248.1201.434	100	1/2	22	27	48.5	33.5	26.0	19.5	12.5	14.300
SO 01221-12,7-3/4	248.1201.436	100	1/2	22	32	51.5	36.5	26.0	19.5	12.5	16.600

d=Rohrussen-ø
e= kleinste Bohrung
L= Mass in montiertem Zustand

d=ø extérieur du tube
e= ø-min. de passage
L=après montage

d=tube outside diameter
e=minimum bore
L=installed length

Gerade Aufschraubverschraubung NPT

Union femelle NPT

Female adaptor union NPT

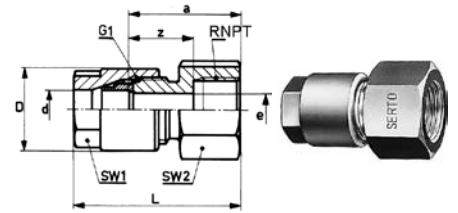

SO 01221 NPT

Type -d -RNPT	Mat.-Nr.	bar	G1	SW1	SW2	L	a	D	z	e	kg/100	
Für metrische Rohre	Pour tubes métriques			For metric tubes								
RNPT=NPT Gewinde	RNPT=Filetage NPT			RNPT=NPT thread								
SO 01221-4-1/8 NPT	248.1202.060	125	1/8	12	14	31.0	24.0	12.0	14.0	4.0	2.600	
SO 01221-4-1/4 NPT	248.1202.065	125	1/8	12	17	35.5	28.5	12.0	14.5	4.0	3.660	
SO 01221-5-1/8 NPT	248.1202.082	125	1/8	12	14	32.0	24.0	12.0	14.0	4.0	2.610	
SO 01221-5-1/4 NPT	248.1202.084	125	1/8	12	17	36.5	28.5	12.0	14.5	4.0	3.670	
SO 01221-6-1/8 NPT	248.1202.100	125	1/8	12	14	32.0	24.0	12.0	14.0	4.0	2.650	
SO 01221-6-1/4 NPT	248.1202.110	125	1/8	12	17	36.5	28.5	12.0	14.5	4.0	3.700	
SO 01221-8-1/8 NPT	248.1202.160	125	1/4	14	14	35.5	25.0	17.0	15.0	6.5	3.900	
SO 01221-8-1/4 NPT	248.1202.170	125	1/4	14	17	39.5	29.0	17.0	15.0	6.5	4.800	
SO 01221-8-3/8 NPT	248.1202.180	125	1/4	14	22	41.5	31.0	17.0	16.0	6.5	6.800	
SO 01221-10-1/4 NPT	248.1202.270	100	3/8	17	17	41.5	29.5	21.0	15.5	8.4	6.700	
SO 01221-10-3/8 NPT	248.1202.280	100	3/8	17	22	42.5	30.0	21.0	16.0	8.4	8.850	
SO 01221-12-3/8 NPT	248.1202.390	100	1/2	19	22	48.0	33.0	26.0	19.0	10.0	11.850	
SO 01221-12-1/2 NPT	248.1202.400	100	1/2	19	27	52.5	37.5	26.0	19.5	12.0	15.850	
SO 01221-14-3/8 NPT	248.1202.502	64	1/2	22	22	50.0	33.5	26.0	19.5	10.0	12.600	
SO 01221-14-1/2 NPT	248.1202.504	64	1/2	22	27	54.5	38.0	26.0	20.0	12.0	15.300	
SO 01221-15-3/8 NPT	248.1202.532	64	1/2	22	22	50.0	33.5	26.0	19.5	10.0	12.750	
SO 01221-15-1/2 NPT	248.1202.534	64	1/2	22	27	54.5	38.0	26.5	20.0	12.0	15.450	

Für Zollrohre	Pour tubes pouces			For inch tubes								
SO 01221-6,35-1/8 NPT	248.1202.135	125	1/8	12	14	32.0	24.0	12.0	14.0	4.0	2.630	
SO 01221-6,35-1/4 NPT	248.1202.140	125	1/8	12	17	33.5	25.5	12.0	14.5	4.0	3.270	
SO 01221-9,52-1/4 NPT	248.1202.230	100	3/8	17	17	39.5	27.0	21.0	16.0	8.4	6.250	
SO 01221-9,52-3/8 NPT	248.1202.235	100	3/8	17	22	40.5	28.0	21.0	16.0	4.5	9.000	
SO 01221-12,7-3/8 NPT	248.1202.432	100	1/2	22	22	48.0	33.0	26.0	19.0	10.0	12.650	
SO 01221-12,7-1/2 NPT	248.1202.434	100	1/2	22	27	52.5	37.5	26.0	19.5	12.0	16.650	

d=Rohraussen-ø
e= kleinste Bohrung
L= Mass in montiertem Zustand

d=ø extérieur du tube
e= ø-min. de passage
L=après montage

d=tube outside diameter
e=minimum bore
L=installed length

4G

Verschraubung

mit Einlötnippel

Union

avec embout à braser

Adaptor union

with soldering nipple

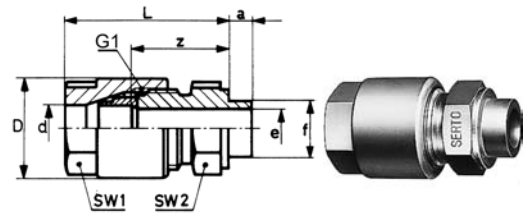
SO 01421

Type-d-f	Mat.-Nr.	bar	G1	SW1	SW2	L	a	D	f	z	e	kg/100
Für metrische Rohre	Pour tubes métriques					For metric tubes						
SO 01421-4-6	248.1400.060	125	1/8	12	12	24.5	3.0	12.0	6.0	17.5	4.0	1.940
SO 01421-5-6	248.1400.080	125	1/8	12	12	25.5	3.0	12.0	6.0	17.5	4.0	1.980
SO 01421-6-6	248.1400.100	125	1/8	12	12	25.5	3.0	12.0	6.0	17.5	4.0	1.990
SO 01421-8-9	248.1400.140	125	1/4	14	14	29.5	4.0	17.0	9.0	19.0	6.0	3.640
SO 01421-10-12	248.1400.185	100	3/8	17	17	32.5	5.0	21.0	12.0	20.0	8.0	6.050
SO 01421-12-14	248.1400.200	100	1/2	19	22	38.5	6.0	26.0	14.0	24.0	10.0	10.700
SO 01421-14-14	248.1400.250	64	1/2	22	22	40.5	6.0	26.0	14.0	24.0	10.0	11.500
SO 01421-15-14	248.1400.270	64	1/2	22	22	40.5	6.0	26.5	14.0	24.0	10.0	11.650
Für Zollrohre	Pour tubes pouces					For inch tubes						
SO 01421-6,35-6	248.1400.120	125	1/8	12	12	25.5	3.0	12.0	6.0	17.5	4.0	1.960
SO 01421-9,52-12	248.1400.164	125	3/8	17	17	32.5	5.0	21.0	12.0	20.0	8.0	6.850
SO 01421-12,7-14	248.1400.216	100	1/2	22	22	38.5	6.0	26.0	14.0	24.0	11.2	11.200

d=Rohraussen-ø
 e= kleinste Bohrung
 L= Mass in montiertem Zustand

d=ø extérieur du tube
 e= ø-min. de passage
 L=après montage

d=tube outside diameter
 e=minimum bore
 L=installed length

Gerade Schottverschraubung

Durchführungslänge max. 5 mm

Union double pour passage de cloison

pour cloison max. 5 mm

Panel mount union

max. panel thickness 5 mm

SO 01521

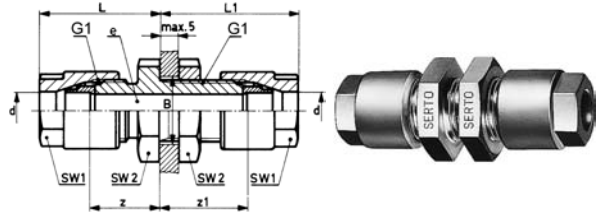

Type -d	Mat.-Nr.	bar	G1	SW1	SW2	L	L1	B	z1	z	e	kg/100
Für metrische Rohre	Pour tubes métriques					For metric tubes						
SO 01521-4	248.1500.040	125	1/8	12	14	23.0	28.0	10.5	21.0	16.0	4.0	4.250
SO 01521-5	248.1500.050	125	1/8	12	14	24.0	29.0	10.5	21.0	16.0	4.0	4.300
SO 01521-6	248.1500.060	125	1/8	12	14	24.0	29.0	10.5	21.0	16.0	4.0	4.300
SO 01521-8	248.1500.080	125	1/4	14	19	27.5	33.5	14.0	23.0	17.0	6.5	8.300
SO 01521-10	248.1500.100	100	3/8	17	24	31.0	36.0	17.0	23.5	18.5	8.5	14.150
SO 01521-12	248.1500.120	100	1/2	19	30	37.0	42.0	21.5	25.5	20.5	12.0	26.500
SO 01521-15	248.1500.150	100	1/2	22	30	41.5	46.5	21.5	27.5	22.5	12.0	27.700

Für Zollrohre	Pour tubes pouces					For inch tubes						
SO 01521-6,35	248.1500.063	125	1/8	12	14	24.0	29.0	10.5	21.0	16.0	4.0	4.270
SO 01521-9,52	248.1500.095	100	3/8	17	24	31.0	36.0	17.0	23.5	18.5	8.5	14.950

Gerade Schottverschraubung

Durchführungslänge max. 16 mm

Union double pour passage de cloison

pour cloison max. 16 mm

Panel mount union

max. panel thickness 16 mm

SO 01524

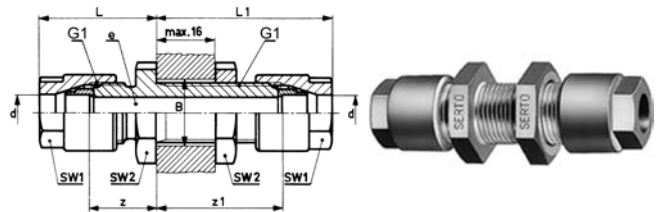

Type -d	Mat.-Nr.	bar	G1	SW1	SW2	L	L1	B	z1	z	e	kg/100
Für metrische Rohre	Pour tubes métriques					For metric tubes						
SO 01524-4	248.1540.040	125	1/8	12	14	23.0	39.0	10.5	32.0	16.0	4.0	4.750
SO 01524-5	248.1540.050	125	1/8	12	14	24.0	40.0	10.5	32.0	16.0	4.0	4.750
SO 01524-6	248.1540.060	125	1/8	12	14	24.0	40.0	10.5	32.0	16.0	4.0	4.800
SO 01524-8	248.1540.080	125	1/4	14	19	27.5	44.5	14.0	34.0	17.0	6.5	9.150
SO 01524-10	248.1540.100	100	3/8	17	24	31.0	47.0	17.0	34.5	18.5	8.5	15.600
SO 01524-12	248.1540.120	100	1/2	19	30	37.0	43.0	21.5	38.5	22.5	12.0	25.700
SO 01524-14	248.1540.140	64	1/2	22	30	39.0	55.0	21.5	38.5	22.5	12.0	27.250
SO 01524-15	248.1540.150	64	1/2	22	30	39.0	55.0	21.5	38.5	22.5	12.0	27.400

Für Zollrohre	Pour tubes pouces					For inch tubes						
SO 01524-6,35	248.1540.063	125	1/8	12	14	24.0	40.0	10.5	32.0	16.0	4.0	4.770
SO 01524-9,52	248.1540.095	125	3/8	17	24	31.0	47.0	17.0	34.5	18.5	8.5	16.400
SO 01524-12,7	248.1540.127	100	1/2	22	30	39.0	55.0	21.5	38.5	22.5	12.0	26.500

d=Rohrassens-ø
e= kleinste Bohrung
L= Mass in montiertem Zustand

d=ø extérieur du tube
e= ø-min. de passage
L=après montage

d=tube outside diameter
e=minimum bore
L=installed length

Schottverschraubung reduziert

Durchführungslänge max. 5mm

Union double réduite pour passage de cloison

pour cloison max. 5 mm

Panel mount reduction union

max. panel thickness 5 mm

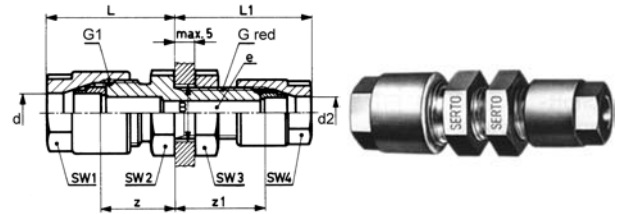

SO 01528

Type -d-d2	Mat.-Nr.	bar	G1	G red	SW1	SW2	SW4	L	L1	z1	z	e	kg/100
Für metrische Rohre	Pour tubes métriques				For metric tubes								
SO 01528-6-4	248.1504.110	125	1/8	1/8	12	14	12	24.0	28.0	21.0	16.0	4.0	4.260
SO 01528-8-6	248.1504.140	125	1/4	1/8	14	14	12	24.0	28.0	21.0	17.0	4.0	5.620
SO 01528-10-6	248.1504.175	100	3/8	1/8	17	17	12	31.0	28.0	21.0	18.5	4.0	8.390
SO 01528-10-8	248.1504.190	100	3/8	1/4	17	19	14	31.0	33.5	23.0	18.5	6.0	10.500
SO 01528-12-10	248.1504.240	100	1/2	3/8	19	24	17	37.0	36.0	23.5	22.0	8.0	17.950
SO 01528-14-10	248.1504.320	64	1/2	3/8	22	24	17	39.0	36.0	23.5	22.0	8.0	18.820
SO 01528-14-12	248.1504.340	64	1/2	1/2	22	30	19	39.0	44.0	27.5	22.5	12.0	24.850
SO 01528-15-10	248.1504.410	64	1/2	3/8	22	24	17	39.0	36.0	23.5	22.0	8.0	19.050
SO 01528-15-12	248.1504.420	64	1/2	1/2	22	30	19	39.0	44.0	27.5	22.5	12.0	24.950
Für Zollrohre	Pour tubes pouces				For inch tubes								
SO 01528-6,35-4	248.1504.123	125	1/8	1/8	12	14	12	24.0	28.0	21.0	16.0	4.0	4.230
SO 01528-8,6-3,5	248.1504.141	125	1/4	1/8	14	14	12	24.0	28.0	21.0	17.0	4.0	5.590
SO 01528-9,52-8	248.1504.162	100	3/8	1/4	17	19	14	31.0	33.5	23.0	18.5	6.0	10.650
SO 01528-12-9,52	248.1504.236	100	1/2	3/8	19	24	17	37.0	36.0	23.5	22.0	8.0	18.100
SO 01528-12,7-9,52	248.1504.270	100	1/2	3/8	22	24	17	37.0	36.0	23.5	22.0	8.0	18.750
SO 01528-12,7-10	248.1504.272	100	1/2	3/8	22	24	17	37.0	36.0	23.5	22.0	8.0	18.600

d=Rohrassens-ø
e= kleinste Bohrung
L= Mass in montiertem Zustand

d=ø extérieur du tube
e= ø-min. de passage
L=après montage

d=tube outside diameter
e=minimum bore
L=installed length

Einstellnippel
Union orientable mâle
Adjustable male adaptor

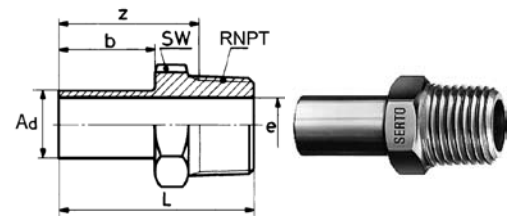

SO 41600

Type -Ad-R	Mat.-Nr.	bar	SW	L	b	z	e	kg/100
SO 41600-A6-1/8	016.1601.100	250	12	26.0	13.0	19.5	4.0	1.000
SO 41600-A6-1/4	016.1601.110	250	14	31.0	13.0	21.0	4.0	1.950
SO 41600-A8-1/8	016.1601.160	150	12	28.0	14.0	21.5	6.0	1.200
SO 41600-A8-1/4	016.1601.170	150	14	32.0	14.0	22.3	6.0	1.800
SO 41600-A10-1/4	016.1601.270	125	14	34.0	16.0	24.3	8.0	1.650
SO 41600-A10-3/8	016.1601.280	125	17	35.0	16.0	23.9	8.0	2.900
SO 41600-A10-1/2	016.1601.285	125	22	37.0	16.0	25.8	8.0	5.570
SO 41600-A12-1/4	016.1601.380	100	14	36.0	18.0	26.3	8.0	1.750
SO 41600-A12-3/8	016.1601.390	100	17	37.0	18.0	25.9	9.0	3.000
SO 41600-A12-1/2	016.1601.400	100	22	41.0	18.0	27.8	9.0	5.670
SO 41600-A14-1/2	016.1601.504	64	22	45.0	21.0	30.8	11.0	5.650
SO 41600-A15-3/8	016.1601.532	64	17	40.0	21.0	28.9	10.5	3.200

Anwendungsbeispiele:

Exemples d'utilisation:

Sample combinations:

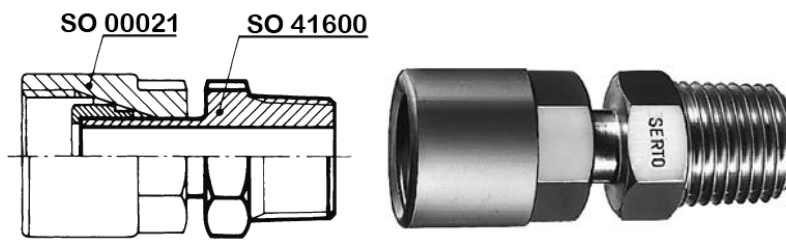

Dieser Einstellnippel ergibt im Zusammenhang mit unserem Armaturenanschluss SO 00021 einen einstellbaren Anschluss.

Cette union montée avec écrou SO 00021 permet d'obtenir un raccord orientable mâle.

In combination with our nut connection SO 00021 this adjustable male adaptor forms an adjustable male adaptor union.

Anwendungsbeispiele:

Exemples d'utilisation:

Sample combinations:

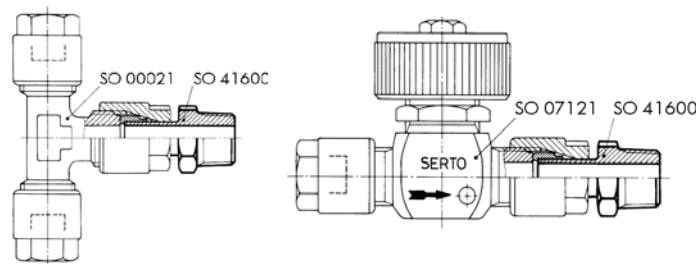

Kombiniert mit Winkel- oder T-Verschraubungen ergeben sich einstellbare Formteile.

Cette union, combinée avec un coude ou un té, permet d'obtenir des raccords orientables.

Produces adjustable configurations in combination with elbow or tee unions.

Ad=Aussen-ø der Andrehung
 e= kleinste Bohrung
 L= Mass in montiertem Zustand

Ad=ø extérieur de la portée cylindrique
 e= ø-min. de passage
 L=après montage

Ad= outside diameter of cyl. stub
 e=minimum bore
 L=installed length

Einstellnippel

Union orientable mâle

Adjustable male adaptor

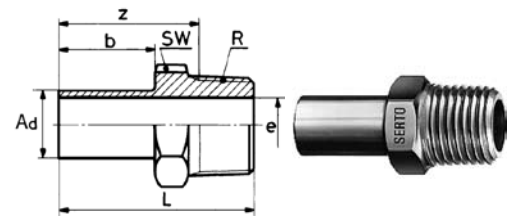

SO 41604

Type -Ad-R	Mat.-Nr.	bar	SW	L	b	z	e	kg/100
radial demontierbar	démontable radialement					radial dismantling		
SO 41604-A15-1/2	016.1611.534	64	22	53.0	30.0	40.0	12.0	5.760
SO 41604-A15-3/4	016.1611.536	64	27	55.5	30.0	41.0	12.0	7.800
SO 41604-A22-1	016.1611.770	40	36	66.0	36.0	49.0	18.0	16.540
SO 41604-A28-1 1/4	016.1611.860	40	46	75.5	41.5	56.5	23.0	33.860

Winkelverschraubung

Coude

Elbow union

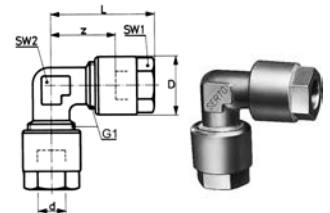

SO 02021

Type -d	Mat.-Nr.	bar	G1	SW1	SW2	L	D	z	e	kg/100
Für metrische Rohre	Pour tubes métriques									
SO 02021-4	248.2000.040	125	1/8	12	10	28.0	12.0	20.0	4.0	3.620
SO 02021-5	248.2000.050	125	1/8	12	10	28.0	12.0	20.0	4.0	3.620
SO 02021-6	248.2000.060	125	1/8	12	10	28.0	12.0	20.0	4.0	3.650
SO 02021-8	248.2000.080	125	1/4	14	11	32.5	17.0	22.0	6.0	6.550
SO 02021-10	248.2000.100	100	3/8	17	14	35.5	21.0	23.0	8.0	10.550
SO 02021-12	248.2000.120	100	1/2	19	17	41.0	26.0	26.5	10.0	17.800
SO 02021-14	248.2000.140	64	1/2	22	19	46.0	26.0	29.5	12.0	19.750
SO 02021-15	248.2000.150	64	1/2	22	19	46.0	26.5	29.5	12.0	19.850
Für Zollrohre	Pour tubes pouces									
SO 02021-6,35	248.2000.063	125	1/8	12	10	28.0	12.0	20.0	4.0	3.620
SO 02021-9,52	248.2000.095	100	3/8	17	14	35.5	21.0	23.0	8.0	10.700
SO 02021-12,7	248.2000.127	100	1/2	22	19	41.0	26.0	26.5	10.0	18.600

d=Rohrussen-ø
e= kleinste Bohrung
L= Mass in montiertem Zustand

d=ø extérieur du tube
e= ø-min. de passage
L=après montage

d=tube outside diameter
e=minimum bore
L=installed length

Anschlusswinkel

mit Wandflansch

Coude femelle

avec applique de fixation

Female adaptor elbow union

with wall flange

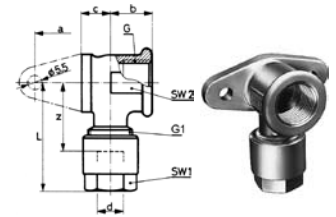

SO 02321

Type -d-G	Mat.-Nr.	bar	G1	SW1	SW2	L	a	b	c	z	e	kg/100
Für metrische Rohre	Pour tubes métriques					For metric tubes						
G=Rohrgewinde (zylindrisch)	G=Filetage-gaz BSP (cylindrique)					G=BSP thread (straight)						
SO 02321-8- ³ / ₈	248.2301.180	125	3/8	17	22	37.5	40.0	16.0	11.0	27.0	6.0	10.500
SO 02321-10- ³ / ₈	248.2301.280	100	3/8	17	22	39.5	40.0	16.0	11.0	27.0	8.0	11.700
SO 02321-10- ¹ / ₂	248.2301.285	100	3/8	17	27	45.5	40.0	22.0	13.0	33.0	8.0	16.900
SO 02321-12- ³ / ₈	248.2301.390	100	1/2	19	22	46.0	40.0	16.0	13.0	31.0	10.0	16.050
SO 02321-12- ¹ / ₂	248.2301.400	100	1/2	19	27	48.0	40.0	22.0	13.0	33.0	12.0	18.600
SO 02321-12- ³ / ₄	248.2301.405	100	1/2	19	32	53.0	46.0	24.0	17.5	38.5	12.0	22.950
SO 02321-14- ³ / ₈	248.2301.502	64	1/2	22	22	48.0	40.0	16.0	13.0	31.5	10.0	16.800
SO 02321-14- ¹ / ₂	248.2301.504	64	1/2	22	27	50.0	40.0	22.0	13.0	33.5	12.0	19.600
SO 02321-14- ³ / ₄	248.2301.506	64	1/2	22	32	55.0	46.0	24.0	17.5	38.5	12.0	26.950
SO 02321-15- ³ / ₈	248.2301.532	64	1/2	22	22	48.0	40.0	16.0	13.0	31.5	10.0	16.800
SO 02321-15- ¹ / ₂	248.2301.534	64	1/2	22	27	50.0	40.0	22.0	13.0	33.5	12.0	19.750
SO 02321-15- ³ / ₄	248.2301.536	64	1/2	22	32	55.0	46.0	24.0	17.5	38.5	12.0	26.650
Für Zollrohre	Pour tubes pouces					For inch tubes						
SO 02321-9,52- ³ / ₈	248.2301.235	100	3/8	17	22	39.5	40.0	16.0	11.0	27.0	8.0	11.850
SO 02321-9,52- ¹ / ₂	248.2301.240	100	3/8	17	22	39.5	40.0	16.0	11.0	27.0	8.0	17.050
SO 02321-12,7- ³ / ₈	248.2301.432	100	1/2	22	19	46.0	40.0	18.0	13.0	31.0	10.0	16.100
SO 02321-12,7- ¹ / ₂	248.2301.434	100	1/2	22	19	48.0	40.0	22.0	13.0	33.0	10.0	18.750
SO 02321-12,7- ³ / ₄	248.2301.436	100	1/2	22	32	53.0	46.0	24.0	17.5	38.5	12.0	23.100

4G

d=Rohraussen-ø
e= kleinste Bohrung
L= Mass in montiertem Zustand

d=ø extérieur du tube
e= ø-min. de passage
L=après montage

d=tube outside diameter
e=minimum bore
L=installed length

Winkel-Einschraubverschraubung

Coude mâle

Male adaptor elbow union

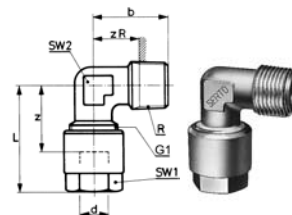

SO 02421

Type -d -R	Mat.-Nr.	bar	G1	SW1	SW2	L	b	zR	z	e	kg/100	
Für metrische Rohre	Pour tubes métriques					For metric tubes						
SO 02421-4-1/8	248.2401.060	125	1/8	12	10	27.0	20.0	13.5	20.0	4.0	2.700	
SO 02421-5-1/8	248.2401.082	125	1/8	12	10	28.0	20.0	13.5	20.0	4.0	2.650	
SO 02421-6-1/8	248.2401.100	125	1/8	12	10	28.0	20.0	13.5	20.0	4.0	2.700	
SO 02421-6-1/4	248.2401.110	125	1/8	12	11	30.0	25.0	15.0	22.0	4.0	3.650	
SO 02421-8-1/8	248.2401.160	125	1/4	14	11	32.5	21.0	14.5	22.0	5.0	4.350	
SO 02421-8-1/4	248.2401.170	125	1/4	14	11	32.5	25.0	15.0	22.0	6.0	4.850	
SO 02421-8-3/8	248.2401.180	125	1/4	14	14	33.5	26.0	16.0	23.0	6.0	6.250	
SO 02421-10-1/4	248.2401.270	100	3/8	17	14	35.5	25.0	15.0	23.0	8.5	7.100	
SO 02421-10-3/8	248.2401.280	100	3/8	17	14	35.5	26.0	16.0	23.0	8.5	7.700	
SO 02421-10-1/2	248.2401.285	100	3/8	17	19	41.5	32.0	19.0	29.0	8.0	11.650	
SO 02421-12-1/4	248.2401.380	100	1/2	19	17	41.0	26.0	16.0	26.5	7.0	11.550	
SO 02421-12-3/8	248.2401.390	100	1/2	19	17	40.0	26.0	16.0	26.5	10.0	11.450	
SO 02421-12-1/2	248.2401.400	100	1/2	19	19	44.0	32.0	19.0	29.5	12.0	13.650	
SO 02421-14-3/8	248.2401.502	64	1/2	22	17	43.0	26.0	16.0	26.5	10.0	12.050	
SO 02421-14-1/2	248.2401.504	64	1/2	22	19	46.0	32.0	19.0	29.5	12.0	14.300	
SO 02421-14-3/4	248.2401.506	64	1/2	22	22	48.0	34.5	20.0	31.5	12.0	18.450	
SO 02421-15-3/8	248.2401.532	64	1/2	22	17	43.0	26.0	16.0	26.5	10.0	12.300	
SO 02421-15-1/2	248.2401.534	64	1/2	22	19	46.0	32.0	19.0	29.5	12.0	14.550	
SO 02421-15-3/4	248.2401.536	64	1/2	22	22	48.0	34.5	20.0	31.5	12.0	18.650	
Für Zollrohre	Pour tubes pouces					For inch tubes						
SO 02421-6,35-1/8	248.2401.135	125	1/8	12	10	28.0	20.0	13.5	20.0	4.0	2.700	
SO 02421-6,35-1/4	248.2401.140	125	1/8	12	10	30.0	22.0	15.0	22.0	4.0	3.650	
SO 02421-9,52-1/4	248.2401.230	100	1/4	17	14	35.5	25.0	15.0	23.0	8.5	7.100	
SO 02421-9,52-3/8	248.2401.235	100	1/4	17	14	35.5	26.0	16.0	23.0	8.5	7.700	
SO 02421-9,52-1/2	248.2401.240	100	1/4	17	19	41.5	32.0	19.0	29.0	8.0	11.650	
SO 02421-12,7-1/4	248.2401.430	100	1/2	19	17	40.0	26.0	16.0	26.2	7.0	11.550	
SO 02421-12,7-3/8	248.2401.432	100	1/2	19	17	40.0	26.0	16.0	26.2	10.0	11.450	
SO 02421-12,7-1/2	248.2401.434	100	1/2	19	19	44.0	32.0	19.0	29.5	12.0	13.350	

d=Rohrøussen-ø
 e= kleinste Bohrung
 L= Mass in montiertem Zustand

d=ø extérieur du tube
 e= ø-min. de passage
 L=après montage

d=tube outside diameter
 L=installed length
 e=minimum bore

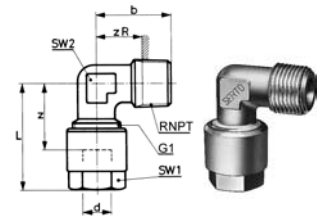
Winkel-Einschraubverschraubung NPT
Coude mâle NPT
Male adaptor elbow union NPT

SO 02421 NPT

Type -d -RNPT	Mat.-Nr.	bar	G1	SW1	SW2	L	b	zR	z	e	kg/100
Für metrische Rohre	Pour tubes métriques			For metric tubes							
RNPT=NPT Gewinde	RNPT=Filetage NPT			RNPT=NPT thread							
SO 02421-4-1/8 NPT	248.2402.060	125	1/8	12	10	27.0	20.0	13.0	20.0	4.0	2.000
SO 02421-5-1/8 NPT	248.2402.082	125	1/8	12	10	28.0	20.0	13.0	20.0	4.0	2.000
SO 02421-6-1/8 NPT	248.2402.100	125	1/8	12	10	28.0	20.0	13.0	20.0	4.0	2.000
SO 02421-6-1/4 NPT	248.2402.110	125	1/8	12	11	30.0	25.0	15.0	22.0	4.0	3.000
SO 02421-8-1/8 NPT	248.2402.160	125	1/4	14	11	32.5	21.0	14.0	22.0	5.0	4.000
SO 02421-8-1/4 NPT	248.2402.170	125	1/4	14	11	32.5	25.0	15.0	22.0	6.0	4.000
SO 02421-10-1/4 NPT	248.2402.270	100	3/8	17	14	35.5	25.0	15.0	23.0	8.5	7.000
SO 02421-10-3/8 NPT	248.2402.280	100	3/8	17	14	35.5	26.0	16.0	23.0	8.5	7.000
SO 02421-12-3/8 NPT	248.2402.390	100	1/2	19	17	41.0	26.0	16.0	26.0	10.0	11.000
SO 02421-12-1/2 NPT	248.2402.400	100	1/2	19	19	44.0	32.0	18.0	29.0	12.0	13.000
SO 02421-14-3/8 NPT	248.2402.502	64	1/2	22	17	43.0	26.0	16.0	26.0	10.0	14.000
SO 02421-14-1/2 NPT	248.2402.504	64	1/2	22	19	46.0	32.0	18.0	29.0	12.0	13.000
SO 02421-15-3/8 NPT	248.2402.532	64	1/2	22	17	43.0	26.0	16.0	26.0	10.0	14.000
SO 02421-15-1/2 NPT	248.2402.534	64	1/2	22	19	46.0	32.0	18.0	29.0	12.0	14.000
Für Zollrohre	Pour tubes pouces			For inch tubes							
SO 02421-6,35-1/8 NPT	248.2402.135	125	1/8	12	10	28.0	20.0	13.0	20.0	4.0	2.000
SO 02421-6,35-1/4 NPT	248.2402.140	125	1/8	12	11	30.0	25.0	15.0	22.0	4.0	3.000
SO 02421-9,52-1/4 NPT	248.2402.230	125	1/4	14	11	32.0	21.0	14.0	22.0	5.0	4.000
SO 02421-9,52-3/8 NPT	248.2402.235	125	1/4	14	11	32.0	25.0	15.0	22.0	6.0	4.000
SO 02421-12,7-3/8 NPT	248.2402.432	100	1/2	19	17	41.0	26.0	16.0	26.0	10.0	11.000
SO 02421-12,7-1/2 NPT	248.2402.434	100	1/2	19	19	44.0	32.0	18.0	29.0	12.0	13.000

4G

d=Rohraussen-ø
e= kleinste Bohrung
L= Mass in montiertem Zustand

d=ø extérieur du tube
e= ø-min. de passage
L=après montage

d=tube outside diameter
L=installed length
e=minimum bore

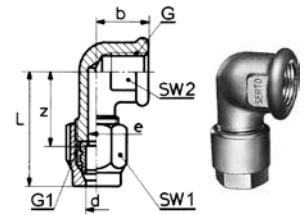
Winkel-Aufschraubverschraubung
Coude femelle
Female adaptor elbow union

SO 02521

Type -d-G	Mat.-Nr.	bar	G1	SW1	SW2	L	b	z	e	kg/100
Für metrische Rohre	Pour tubes métriques		For metric tubes							
G=Rohrgewinde (zylindrisch)	G=Filetage-gaz BSP (cylindrique)		G=BSP thread (straight)							
SO 02521-4-1/8	248.2501.060	125	1/8	12	14	29.0	12.0	22.0	4.0	2.900
SO 02521-5-1/8	248.2501.082	125	1/8	12	14	30.0	12.0	22.0	4.0	2.850
SO 02521-6-1/8	248.2501.100	125	1/8	12	14	30.0	12.0	22.0	4.0	2.900
SO 02521-6-1/4	248.2501.110	125	1/4	14	19	34.5	14.0	25.0	6.0	5.700
SO 02521-8-1/4	248.2501.170	125	1/4	14	19	35.5	14.0	25.0	6.0	5.550
SO 02521-8-3/8	248.2501.180	125	3/8	17	22	39.0	16.0	27.0	8.0	8.350
SO 02521-10-3/8	248.2501.280	100	3/8	17	22	39.5	16.0	27.0	8.0	8.150
SO 02521-10-1/2	248.2501.285	100	3/8	17	27	45.5	22.0	33.0	8.0	13.100
SO 02521-12-3/8	248.2501.390	100	1/2	19	22	44.0	18.0	29.5	10.0	12.750
SO 02521-12-1/2	248.2501.400	100	1/2	19	27	48.0	22.0	33.5	12.0	15.150
SO 02521-12-3/4	248.2501.405	100	1/2	19	32	53.0	24.0	38.5	12.0	19.800
SO 02521-14-3/8	248.2501.502	64	1/2	22	22	46.0	18.0	29.5	10.0	13.550
SO 02521-14-1/2	248.2501.504	64	1/2	22	27	50.0	22.0	33.5	12.0	15.350
SO 02521-14-3/4	248.2501.506	64	1/2	22	32	50.0	24.0	33.5	12.0	20.300
SO 02521-15-3/8	248.2501.532	64	1/2	22	22	46.0	18.0	29.5	10.0	13.650
SO 02521-15-1/2	248.2501.534	64	1/2	22	27	50.0	22.0	33.5	12.0	15.950
SO 02521-15-3/4	248.2501.536	64	1/2	22	32	55.0	24.0	38.5	12.0	20.400
Für Zollrohre	Pour tubes pouces		For inch tubes							
SO 02521-6,35-1/8	248.2501.135	125	1/8	12	14	30.0	14.0	22.0	4.0	2.870
SO 02521-6,35-1/4	248.2501.140	125	1/4	14	19	34.5	14.0	25.0	6.0	5.830
SO 02521-9,52-3/8	248.2501.235	100	3/8	17	22	39.5	16.0	27.0	8.0	8.950
SO 02521-9,52-1/2	248.2501.240	100	1/2	17	22	39.5	16.0	27.0	8.0	13.900
SO 02521-12,7-3/8	248.2501.432	100	3/8	22	22	44.0	18.0	29.5	10.0	13.550
SO 02521-12,7-1/2	248.2501.434	100	1/2	22	27	48.0	22.0	33.5	10.0	15.950
SO 02521-12,7-3/4	248.2501.436	100	3/4	22	32	53.0	24.0	38.5	10.0	20.600

d=Rohrøussen-ø
 e= kleinste Bohrung
 L= Mass in montiertem Zustand

d=ø extérieur du tube
 e= ø-min. de passage
 L=après montage

d=tube outside diameter
 e=minimum bore
 L=installed length

Winkelverschraubung

mit Einstellzapfen

Coude orientable

Adjustable elbow union

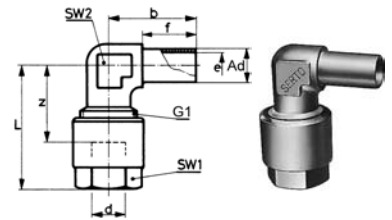

SO 02621

Type -d -Ad	Mat.-Nr.	bar	G1	SW1	SW2	L	b	f	z	e	kg/100
SO 02621-6-A6	248.2600.060	125	1/8	12	10	28.0	19.0	13.0	20.0	4.0	2.250
SO 02621-8-A8	248.2600.080	125	1/4	14	11	32.5	22.0	14.0	22.0	6.0	4.000
SO 02621-10-A10	248.2600.100	100	3/8	17	14	35.5	26.0	16.0	23.0	8.0	6.300
SO 02621-12-A12	248.2600.120	100	1/2	19	19	44.0	31.0	18.0	29.5	9.0	12.900
SO 02621-14-A14	248.2600.140	64	1/2	22	19	46.0	32.0	21.0	29.5	11.0	12.950
SO 02621-15-A15	248.2600.150	64	1/2	22	19	46.0	35.0	21.0	29.5	12.0	13.200

Anwendungsbeispiele:

Exemples d'utilisation:

Sample combinations:

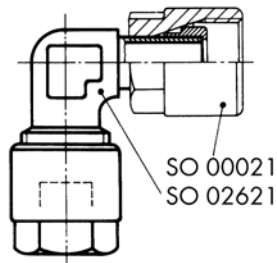

Dieser Einstellwinkel ergibt im Zusammenhang mit unserem Armaturenanschluss SO 00021 -d-G einen einstellbaren Winkelanschluss.

L'assemblage du SO 00021 -d-G donne un coude parfaitement orientable.

In combination with our nut connection SO 00021 -d-G, this elbow forms an adjustable female adaptor elbow.

Anwendungsbeispiele:

Exemples d'utilisation:

Sample combinations:

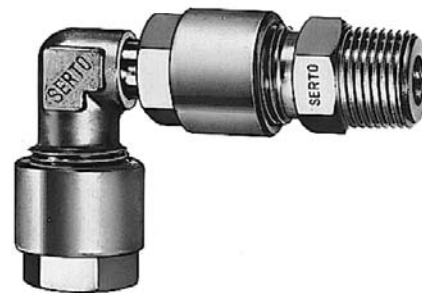
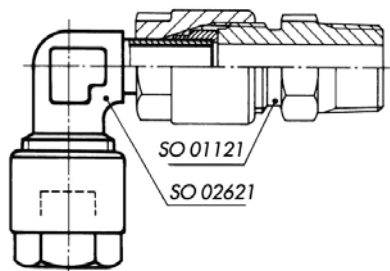

Gegenüber dem Einschraubwinkel lässt sich diese Kombination einfacher einstellen, da Einschrauben und Ausrichten getrennt voneinander vorgenommen werden.

Par opposition à un coude mâle, cette combinaison permet un positionnement plus facile. Le raccordement et l'orientation se font séparément.

In contrast to the simple male adaptor elbow union, this combination is easier to adjust, since screw-on and aligning are performed separately.

d=Rohrassen- \varnothing
Ad=Aussen- \varnothing der Andrehung
e= kleinste Bohrung
L= Mass in montiertem Zustand

d= \varnothing extérieur du tube
Ad= \varnothing extérieur de la portée cylindrique
e= \varnothing -min. de passage
L=après montage

d=tube outside diameter
Ad=outside diameter of cyl. stub
e=minimum bore
L=installed length

Winkel-Schottverschraubung

Durchführungslänge max. 5 mm

Coude pour passage de cloison

pour cloison max. 5 mm

Panel mount elbow union

max. panel thickness 5 mm

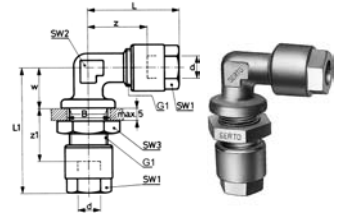

SO 02721

Type-d	Mat.-Nr.	bar	SW1	SW2	SW3	L	L1	B	w	z1	z	e	kg/100
Für metrische Rohre	Pour tubes métriques					For metric tubes							
SO 02721-4	248.2700.040	125	12	10	14	27.0	42.0	10.5	14.0	21.0	20.0	4.0	4.900
SO 02721-5	248.2700.050	125	12	10	14	28.0	43.0	10.5	14.0	21.0	20.0	4.0	4.900
SO 02721-6	248.2700.060	125	12	10	14	28.0	43.0	10.5	14.0	21.0	20.0	4.0	4.900
SO 02721-8	248.2700.080	125	14	11	19	35.0	50.5	14.0	17.0	23.0	22.0	6.0	9.300
SO 02721-10	248.2700.100	100	17	17	24	38.5	54.0	17.0	18.0	23.5	26.0	8.5	15.100
SO 02721-12	248.2700.120	100	19	19	30	44.0	62.0	21.5	20.0	27.5	29.5	12.0	25.100
SO 02721-14	248.2700.140	64	22	19	30	46.0	64.0	21.5	20.0	27.5	29.5	12.0	27.850
SO 02721-15	248.2700.150	64	22	19	30	46.0	64.0	21.5	20.0	27.5	29.5	12.0	27.100
Für Zollrohre	Pour tubes pouces					For inch tubes							
SO 02721-6,35	248.2700.063	125	12	10	14	28.0	43.0	10.5	14.0	21.0	20.0	4.0	4.900
SO 02721-9,52	248.2700.095	100	17	14	24	38.5	54.0	17.0	18.0	23.5	26.0	8.0	15.900
SO 02721-12,7	248.2700.127	100	22	19	30	46.0	64.0	21.5	20.0	27.5	29.5	12.0	25.900

T-Verschraubung

Té

Tee union

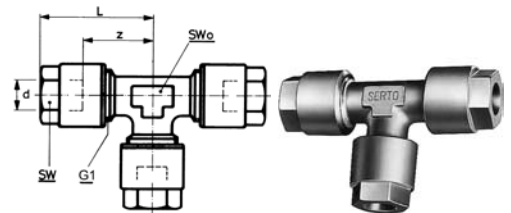

SO 03021

Type-d	Mat.-Nr.	bar	G1	SW	SW0	L	z	e	kg/100
Für metrische Rohre	Pour tubes métriques					For metric tubes			
SO 03021-4	248.3000.040	125	1/8	12	10	27.0	20.0	4.0	5.400
SO 03021-5	248.3000.050	125	1/8	12	10	28.0	20.0	4.0	5.250
SO 03021-6	248.3000.060	125	1/8	12	10	28.0	20.0	4.0	5.250
SO 03021-8	248.3000.080	125	1/4	14	11	32.5	22.0	6.0	9.550
SO 03021-10	248.3000.100	100	3/8	17	14	35.5	23.0	8.0	15.550
SO 03021-12	248.3000.120	100	1/2	19	19	44.0	26.5	11.0	26.050
SO 03021-14	248.3000.140	64	1/2	22	19	46.0	26.5	11.0	28.750
SO 03021-15	248.3000.150	64	1/2	22	19	46.0	26.5	11.0	29.150
Für Zollrohre	Pour tubes pouces					For inch tubes			
SO 03021-6,35	248.3000.063	125	1/8	12	10	28.0	20.0	4.0	5.250
SO 03021-9,52	248.3000.095	100	3/8	17	14	35.5	23.0	8.0	16.350
SO 03021-12,7	248.3000.127	100	1/2	22	19	46.0	26.5	11.0	27.700

d=Rohrassens-ø
e= kleinste Bohrung
L= Mass in montiertem Zustand

d=ø extérieur du tube
e= ø-min. de passage
L=après montage

d=tube outside diameter
e=minimum bore
L=installed length

T-Verschraubung reduziert

Té réduit

Tee reduction union

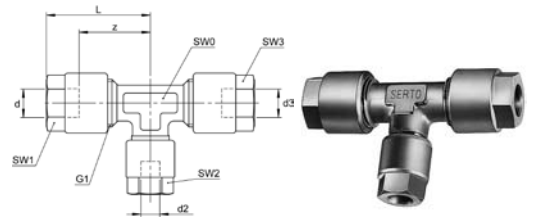

SO 03021 RED

Type -d1 -d2 -d3	Mat.-Nr.	bar	G1	SW0	SW1	SW2	SW3	L	z	e	kg/100
SO 03021-6-8-6	248.3004.058	125	1/4	11	14	14	14	32.5	22.0	6.0	9.900
SO 03021-8-6-6	248.3004.091	125	1/4	11	14	14	14	32.5	22.0	6.0	9.900
SO 03021-8-6-8	248.3004.093	125	1/4	11	14	14	14	32.5	22.0	6.0	9.650
SO 03021-8-8-6	248.3004.100	125	1/4	11	14	14	14	32.5	22.0	6.0	9.650
SO 03021-12-14-12	248.3004.246	64	1/2	19	19	22	19	46.0	29.5	12.0	27.300
SO 03021-12-15-12	248.3004.254	64	1/2	19	19	22	19	46.0	29.5	12.0	27.400
SO 03021-14-12-12	248.3004.342	64	1/2	19	22	19	19	46.0	29.5	12.0	27.300
SO 03021-14-12-14	248.3004.346	64	1/2	19	22	19	22	46.0	29.5	12.0	28.000
SO 03021-14-14-12	248.3004.361	64	1/2	19	22	22	19	46.0	29.5	12.0	28.000
SO 03021-15-12-12	248.3004.417	64	1/2	19	22	19	19	46.0	29.5	12.0	27.600
SO 03021-15-12-15	248.3004.422	64	1/2	19	22	19	22	46.0	29.5	12.0	28.600
SO 03021-15-15-12	248.3004.435	64	1/2	19	22	22	19	46.0	29.5	12.0	28.600

T-Verschraubung reduziert

Té réduit

Tee reduction union

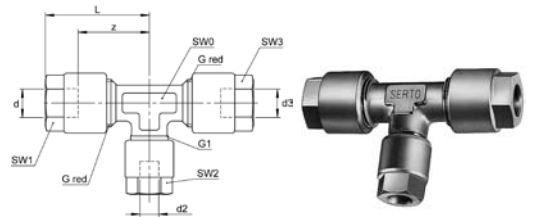

4G

SO 03021 RED V1

Type -d -d2 -d3	Mat.-Nr.	bar	G1	G red	SW0	SW1	SW2	SW3	L	z	e	kg/100
SO 03021-6-10-6	248.3004.062	100	3/8	1/4	14	14	17	14	35.5	23.0	8.0	12.600
SO 03021-8-10-8	248.3004.104	100	3/8	1/4	14	14	17	14	35.5	23.0	8.0	12.500
SO 03021-8-12-8	248.3004.107	100	1/2	3/8	17	19	19	19	41.0	27.0	10.0	22.900
SO 03021-10-12-10	248.3004.165	100	1/2	3/8	17	17	19	17	41.0	26.0	10.0	21.200
SO 03021-10-15-10	248.3004.175	64	1/2	3/8	17	17	22	17	43.5	29.5	10.0	22.100

Version 1

Version 1

Version 1

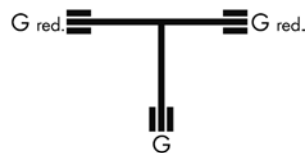

d=Rohrussen-ø
e=kleinste Bohrung
L=Mass in montiertem Zustand

d=ø extérieur du tube
e=ø min. de passage
L=après montage

d=tube outside diameter
e=minimum bore
L=installed length

T-Verschraubung reduziert

Té réduit

Tee reduction union

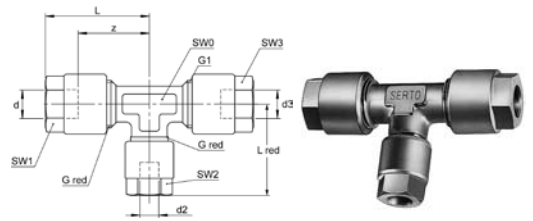

SO 03021 RED V2

Type -d -d2 -d3	Mat.-Nr.	bar	G1	G red	SW0	SW1	SW2	SW3	L	z	e	kg/100
SO 03021-6-6-10	248.3004.143	100	3/8	1/4	14	17	17	17	36.5	24.0	8.0	12.600
SO 03021-8-8-10	248.3004.151	100	3/8	1/4	14	14	14	17	35.5	23.0	8.0	12.500
SO 03021-6-6-12	248.3004.195	100	1/2	3/8	17	17	17	19	41.0	26.0	10.0	22.700
SO 03021-8-8-12	248.3004.206	100	1/2	3/8	17	17	17	19	41.0	26.0	10.0	20.400
SO 03021-10-10-12	248.3004.220	100	1/2	3/8	17	17	17	19	41.0	26.0	10.0	21.200
SO 03021-10-10-15	248.3004.403	64	1/2	3/8	19	17	17	22	46.0	29.5	12.0	22.900

Version 2

Version 2

Version 2

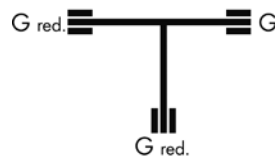

T-Verschraubung reduziert

Té réduit

Tee reduction union

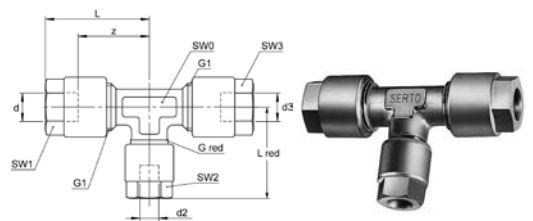

SO 03021 RED V3

Type -d -d2 -d3	Mat.-Nr.	bar	G1	G red	SW0	SW1	SW2	SW3	L	z	e	kg/100
SO 03021-10-6-10	248.3004.147	100	3/8	1/4	14	17	14	17	35.5	23.0	8.0	13.900
SO 03021-10-8-10	248.3004.153	100	3/8	1/4	14	17	14	17	35.5	23.0	8.0	13.900
SO 03021-12-6-12	248.3004.200	100	1/2	3/8	17	19	17	19	41.0	26.0	10.0	23.900
SO 03021-12-8-12	248.3004.210	100	1/2	3/8	17	19	17	19	41.0	26.0	10.0	23.700
SO 03021-12-10-12	248.3004.222	100	1/2	3/8	17	19	17	19	41.0	26.0	10.0	23.500
SO 03021-14-8-14	248.3004.320	64	1/2	3/8	19	22	17	22	46.0	29.5	12.0	26.500
SO 03021-14-10-12	248.3004.330	64	1/2	3/8	19	22	17	19	46.0	29.5	12.0	25.100
SO 03021-15-8-15	248.3004.393	64	1/2	3/8	19	22	17	22	46.0	29.5	12.0	26.500
SO 03021-15-10-12	248.3004.405	64	1/2	3/8	19	22	17	19	46.0	29.5	12.0	25.600
SO 03021-15-10-15	248.3004.410	64	1/2	3/8	19	22	17	22	46.0	29.5	12.0	26.000

Version 3

Version 3

Version 3

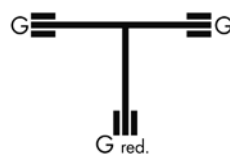

d=Rohrassens-ø
e=kleinste Bohrung
L=Mass in montiertem Zustand

d=ø extérieur du tube
e=ø min. de passage
L=après montage

d=tube outside diameter
e=minimum bore
L=installed length

T-Verschraubung reduziert

Té réduit

Tee reduction union

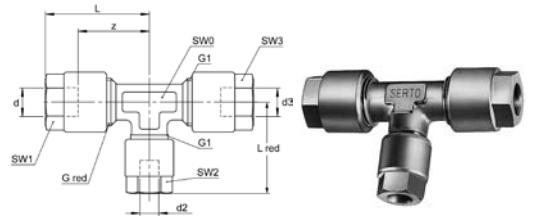

SO 03021 RED V4

Type -d -d2 -d3	Mat.-Nr.	bar	G1	G red	SW0	SW1	SW2	SW3	L	L red	z	e	kg/100
SO 03021-6-10-10	248.3004.158	100	3/8	1/4	14	14	17	17	35.5	35.5	23.0	8.0	14.100
SO 03021-8-10-10	248.3004.161	100	3/8	1/4	14	14	17	17	35.5	35.5	23.0	8.0	13.900
SO 03021-6-12-12	248.3004.226	100	1/2	3/8	17	17	19	19	41.0	37.5	26.0	10.0	24.000
SO 03021-8-12-12	248.3004.229	100	1/2	3/8	17	17	19	19	41.0	38.0	26.0	10.0	24.150
SO 03021-8-14-14	248.3004.356	64	1/2	3/8	19	19	22	22	46.0	41.0	29.5	12.0	25.400
SO 03021-8-15-15	248.3004.430	64	1/2	3/8	19	17	22	22	46.0	41.0	29.5	12.0	26.300
SO 03021-10-12-12	248.3004.232	100	1/2	3/8	17	17	19	19	41.0	38.5	26.0	10.0	23.500
SO 03021-10-14-12	248.3004.244	64	1/2	3/8	19	19	22	17	46.0	41.5	29.5	12.0	25.150
SO 03021-10-12-14	248.3004.340	64	1/2	3/8	19	17	19	22	46.0	41.5	29.5	12.0	25.100
SO 03021-10-15-12	248.3004.252	64	1/2	3/8	19	17	22	19	46.0	41.5	29.5	12.0	24.900
SO 03021-10-12-15	248.3004.415	64	1/2	3/8	19	17	19	22	46.0	41.5	29.5	12.0	25.600
SO 03021-10-15-15	248.3004.433	64	1/2	3/8	19	17	22	22	46.0	41.5	29.5	12.0	26.000

Version 4

Version 4

Version 4

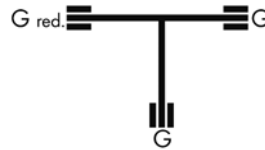

4G

d=Rohrussen-ø
e=kleinste Bohrung
L=Mass in montiertem Zustand

d=ø extérieur du tube
e=ø min. de passage
L=après montage

d=tube outside diameter
e=minimum bore
L=installed length

T-Verschraubung

mit Einstellzapfen

Té orientable

Adjustable Tee union

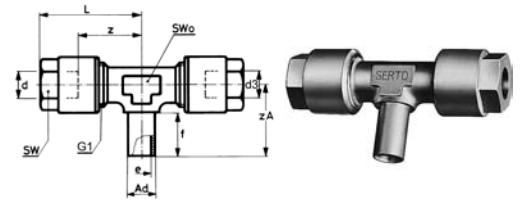

SO 03621 T

Type -d -Ad -d3	Mat.-Nr.	bar	G1	SW	SW0	L	f	zA	z	e	kg/100
SO 03621-6-A6-6	248.3600.060	125	1/8	12	10	28.0	13.0	19.0	20.0	4.0	3.850
SO 03621-8-A8-8	248.3600.080	125	1/4	14	11	32.5	14.0	22.0	22.0	6.0	7.350
SO 03621-10-A10-10	248.3600.100	100	3/8	17	14	35.5	16.0	26.0	23.0	8.0	11.200

Anwendungsbeispiele:

Exemples d'utilisation:

Sample combinations:

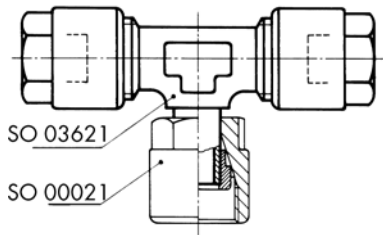

Der Einstell-T ergibt im Zusammenhang mit unserem Armaturenanschluss SO 00021 -d-G eine einstellbare T-Kombination.

L'assemblage du SO 03621 et d'un écrou SO 00021 -d-G donne un Té parfaitement orientable.

In combination with our nut connection SO 00021 -d-G, the adjustable Tee union forms an adjustable female adaptor Tee union.

L-Verschraubung

mit Einstellzapfen

L orientable

Adjustable L union

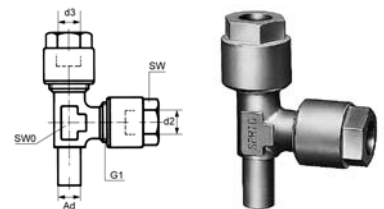

SO 03621 L

Type -Ad -d2 -d3	Mat.-Nr.	bar	G1	SW	SW0	L	f	zA	z	e	kg/100
SO 03621-A6-6-6	248.3610.060	125	1/8	12	10	28.0	13.0	19.0	20.0	4.0	3.850
SO 03621-A8-8-8	248.3610.080	125	1/4	14	11	32.5	14.0	22.0	22.0	6.0	7.350
SO 03621-A10-10-10	248.3610.100	100	3/8	17	14	35.5	16.0	26.0	23.0	8.0	11.200

Gegenüber der T-Verschraubung mit Übergangsmuffe SO 03221 kann das Manometer besser ausgerichtet werden.

Cette combinaison est très favorable pour le positionnement d'un manomètre.

In comparison to the Tee union with female adapter SO 03221, the pressure gauge can be aligned more easily.

Mit der T-Verschraubung mit Einstellzapfen können Montagen ohne Zwischenstück sehr leicht hergestellt werden.

Ce Té orientable facilite bien des montages et élimine les adaptateurs.

With the aid of the adjustable Tee union, installations can be made easily without the use of adaptors.

d=Rohrassens-ø
Ad=Aussen-ø der Andrehung
e= kleinste Bohrung
L= Mass in montiertem Zustand

d=ø extérieur du tube
Ad=ø extérieur de la portée cylindrique
e= ø-min. de passage
L=après montage

d=tube outside diameter
Ad= outside diameter of cyl. stub
e=minimum bore
L=installed length

T-Einschraubverschraubung

T mâle

Male adaptor Tee union

SO 03721 T

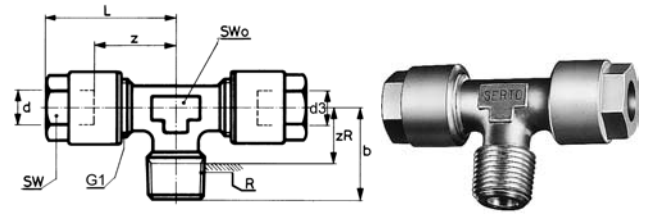

Type -d -R -d3	Mat.-Nr.	bar	G1	SW	SWO	L	b	zR	z	e	kg/100
Für metrische Rohre	Pour tubes métriques	For metric tubes									
R=Rohrgewinde (kegelig)	R=Filetage-gaz BSP (conique)	R=BSP thread (tapered)									
SO 03721-4-1/8-4	248.3701.040	125	1/8	10	10	27.0	20.0	13.5	20.0	4.0	4.250
SO 03721-5-1/8-5	248.3701.070	125	1/8	12	10	28.0	20.0	13.5	20.0	4.0	4.250
SO 03721-6-1/8-6	248.3701.100	125	1/8	12	10	28.0	20.0	13.5	20.0	4.0	4.350
SO 03721-6-1/4-6	248.3701.110	125	1/8	12	11	30.0	25.0	15.0	22.0	4.0	5.550
SO 03721-8-1/4-8	248.3701.170	125	1/4	14	11	32.5	25.0	15.0	22.0	6.0	7.900
SO 03721-10-1/4-10	248.3701.270	100	3/8	17	14	35.5	25.0	15.0	23.0	8.0	11.950
SO 03721-10-3/8-10	248.3701.280	100	3/8	17	14	35.5	26.0	16.0	23.0	8.0	12.550

Für Zollrohre	Pour tubes pouces	For inch tubes									
SO 03721-6,35-1/8-6,35	248.3701.140	125	1/8	12	10	28.0	20.0	13.5	20.0	4.0	4.330
SO 03721-6,35-1/4-6,35	248.3701.145	125	1/8	12	11	30.0	25.0	15.0	22.0	4.0	5.520
SO 03721-9,52-1/4-9,52	248.3701.210	100	3/8	17	14	35.5	25.0	15.0	23.0	8.0	12.100
SO 03721-9,52-3/8-9,52	248.3701.215	100	3/8	17	14	35.5	25.0	15.0	23.0	8.0	13.350

L-Einschraubverschraubung

L mâle

Male adaptor L union

SO 03721 L

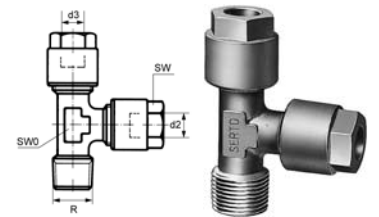

Type -R -d2 -d3	Mat.-Nr.	bar	G1	SW	SWO	L	b	zR	z	e	kg/100
Für metrische Rohre	Pour tubes métriques	For metric tubes									
R=Rohrgewinde (kegelig)	R=Filetage-gaz BSP (conique)	R=BSP thread (tapered)									
SO 03721-1/8-4-4	248.3711.050	125	1/8	10	10	27.0	20.0	13.5	20.0	4.0	4.250
SO 03721-1/8-5-5	248.3711.070	125	1/8	12	10	28.0	20.0	13.5	20.0	4.0	4.250
SO 03721-1/8-6-6	248.3711.100	125	1/8	12	10	28.0	20.0	13.5	20.0	4.0	4.350
SO 03721-1/4-6-6	248.3711.180	125	1/8	12	11	30.0	25.0	15.0	22.0	4.0	5.550
SO 03721-1/4-8-8	248.3711.220	125	1/4	14	11	32.5	25.0	15.0	22.0	6.0	7.900
SO 03721-1/4-10-10	248.3711.260	100	3/8	17	14	35.5	25.0	15.0	23.0	8.0	11.950
SO 03721-3/8-10-10	248.3711.320	100	3/8	17	14	35.5	26.0	16.0	23.0	8.0	12.550

Für Zollrohre	Pour tubes pouces	For inch tubes									
SO 03721-1/8-6,35-6,35	248.3711.110	125	1/8	12	10	28.0	20.0	13.5	20.0	4.0	4.330
SO 03721-1/4-6,35-6,35	248.3711.190	125	1/8	12	11	30.0	25.0	15.0	22.0	4.0	5.530
SO 03721-1/4-9,52-9,52	248.3711.240	100	3/8	17	14	35.5	25.0	15.0	23.0	8.0	12.750
SO 03721-3/8-9,52-9,52	248.3711.290	100	3/8	17	14	35.5	26.0	16.0	23.0	8.0	13.350

d=Rohrassen-ø
Ad=Aussen-ø der Andrehung
e= kleinste Bohrung
L= Mass in montiertem Zustand

d=ø extérieur du tube
Ad=ø extérieur de la portée cylindrique
e= ø-min. de passage
L=après montage

d=tube outside diameter
Ad= outside diameter of cyl. stub
e=minimum bore
L=installed length

Kreuzverschraubung

Croix

Cross union

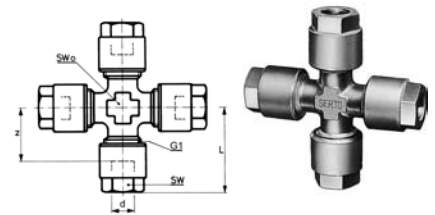

SO 04021

Type -d	Mat.-Nr.	bar	G1	SW	SW0	L	z	e	kg/100
Für metrische Rohre	Pour tubes métriques			For metric tubes					
SO 04021-4	248.4000.040	125	1/8	12	10	27.0	20.0	4.0	6.750
SO 04021-5	248.4000.050	125	1/8	12	10	28.0	20.0	4.0	6.800
SO 04021-6	248.4000.060	125	1/8	12	10	28.0	20.0	4.0	6.800
SO 04021-8	248.4000.080	125	1/4	14	11	32.5	22.0	6.0	12.550
SO 04021-10	248.4000.100	100	3/8	17	14	35.5	23.0	8.0	20.300
SO 04021-12	248.4000.120	100	1/2	19	19	44.0	29.5	12.0	33.750
SO 04021-14	248.4000.140	64	1/2	22	19	46.0	29.5	12.0	38.700
SO 04021-15	248.4000.150	64	1/2	22	19	46.0	29.5	12.0	37.800
Für Zollrohre	Pour tubes pouces			For inch tubes					
SO 04021-6,35	248.4000.063	125	1/8	12	10	28.0	20.0	4.0	6.770
SO 04021-9,52	248.4000.095	100	3/8	17	14	35.5	23.0	8.0	20.450
SO 04021-12,7	248.4000.127	100	1/2	22	19	46.0	29.5	12.0	38.700

Kreuzverschraubung reduziert

Croix réduite

Cross reduction union

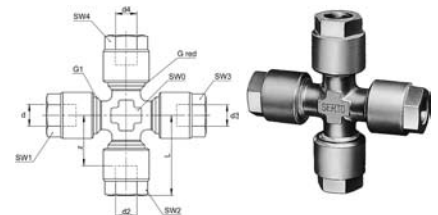

SO 04021 RED

Type -d -d2 -d3 -d4	Mat.-Nr.	bar	G1	G red	SW0	SW1	SW2	SW3	SW4	L	z	e	kg/100
Für metrische Rohre	Pour tubes métriques			For metric tubes									
SO 04021-8-6-6-6	248.4004.076	125	1/4	1/4	11	14	14	14	14	31.5	22.0	6.0	12.750
SO 04021-10-8-8-8	248.4004.097	100	3/8	3/8	14	17	17	17	17	35.5	23.0	8.0	20.650
SO 04021-12-10-10-10	248.4004.117	100	1/2	3/8	19	19	19	19	19	44.0	29.5	12.0	28.550
SO 04021-14-10-10-10	248.4004.135	64	1/2	3/8	19	22	19	19	19	46.0	29.5	12.0	29.250
SO 04021-14-12-12-12	248.4004.137	64	1/2	1/2	19	22	19	19	19	46.0	29.5	12.0	36.750
SO 04021-15-10-10-10	248.4004.144	64	1/2	3/8	19	22	19	19	19	46.0	29.5	12.0	29.400
SO 04021-15-12-12-12	248.4004.146	64	1/2	1/2	19	22	19	19	19	46.0	29.5	12.0	34.650

d=Rohrussen-ø
e=kleinste Bohrung
L=Mass in montiertem Zustand

d=ø extérieur du tube
e=ø-min. de passage
L=après montage

d=tube outside diameter
e=minimum bore
L=installed length

Winkel-Verteilerverschraubung

Distributeur

V distributor union

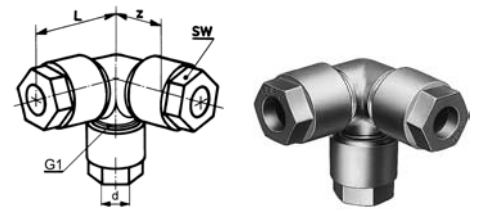

SO 05021

Type -d	Mat.-Nr.	bar	G1	SW	z	L	e	kg/100
Für metrische Rohre	Pour tubes métriques	For metric tubes						
SO 05021-4	248.5000.040	125	1/8	12	20.0	27.0	4.0	5.550
SO 05021-5	248.5000.050	125	1/8	12	20.0	28.0	4.0	5.600
SO 05021-6	248.5000.060	125	1/8	12	20.0	28.0	4.0	5.650
SO 05021-8	248.5000.080	125	1/4	14	22.0	32.5	6.0	10.950
SO 05021-10	248.5000.100	100	3/8	17	23.0	35.5	8.0	17.850
SO 05021-12	248.5000.120	100	1/2	19	29.5	44.0	12.0	29.950
SO 05021-14	248.5000.140	64	1/2	22	29.5	46.0	12.0	32.350
SO 05021-15	248.5000.150	64	1/2	22	29.5	46.0	12.0	32.450
Für Zollrohre	Pour tubes pouces	For inch tubes						
SO 05021-6,35	248.5000.063	125	1/8	12	20.0	28.0	4.0	5.630
SO 05021-9,52	248.5000.095	100	3/8	17	23.0	35.5	8.0	18.650
SO 05021-12,7	248.5000.127	100	1/2	22	29.5	46.0	12.0	33.250

Winkel-Verteilerverschraubung reduziert

Distributeur réduit

V reduction distributor

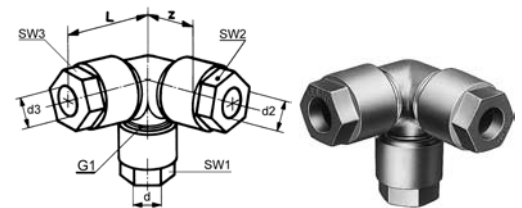

SO 05021 RED

Type -d -d2 -d3	Mat.-Nr.	bar	G1	G red	SW1	SW2	SW3	z	L	e	kg/100
SO 05021-8-6-6	248.5004.091	125	1/4	1/4	14	14	14	22.0	32.5	6.0	11.000
SO 05021-10-8-8	248.5004.151	100	3/8	1/4	17	17	17	23.0	35.5	8.0	18.100
SO 05021-12-10-10	248.5004.220	100	1/2	3/8	19	17	17	29.5	44.0	12.0	25.700
SO 05021-14-10-10	248.5004.328	64	1/2	1/2	22	17	17	29.5	46.0	12.0	28.150
SO 05021-14-12-12	248.5004.342	64	1/2	1/2	22	19	19	29.5	46.0	12.0	27.800
SO 05021-15-10-10	248.5004.403	64	1/2	1/2	22	17	17	29.5	46.0	12.0	30.900
SO 05021-15-12-12	248.5004.417	64	1/2	1/2	22	19	19	29.5	46.0	12.0	31.150

d=Rohrassens-ø
e= kleinste Bohrung
L= Mass in montiertem Zustand

d=ø extérieur du tube
e= ø-min. de passage
L=après montage

d=tube outside diameter
e=minimum bore
L=installed length

Anschlussvarianten mit Übergangsmuffe

Variantes de raccordement avec adaptateur femelle

Connections with female adaptor

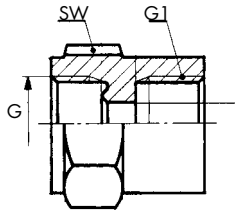
SO 00030
SO 02221
SO 03221
SO 04221
SO 05221

G	-	G1	SW	-d	-G	-d	-G	-d	-G	-d	-d	-d	-d	-G	d
1/8	-	1/8	14	-4	-1/8	-4	-1/8	-4	-1/8	-4	-4	-4	-4	-1/8	-4
1/8	-	1/4	19	-4	-1/4	-4	-1/4	-4	-1/4	-4	-4	-4	-4	-1/4	-4
1/8	-	3/8	22	-4	-3/8	-4	-3/8	-4	-3/8	-4	-4	-4	-4	-3/8	-4
1/8	-	1/2	27	-4	-1/2	-4	-1/2	-4	-1/2	-4	-4	-4	-4	-1/2	-4
1/8	-	1/8	14	-5	-1/8	-5	-1/8	-5	-1/8	-5	-5	-5	-5	-1/8	-5
1/8	-	1/4	19	-5	-1/4	-5	-1/4	-5	-1/4	-5	-5	-5	-5	-1/4	-5
1/8	-	3/8	22	-5	-3/8	-5	-3/8	-5	-3/8	-5	-5	-5	-5	-3/8	-5
1/8	-	1/2	27	-5	-1/2	-5	-1/2	-5	-1/2	-5	-5	-5	-5	-1/2	-5
1/8	-	1/8	14	-6	-1/8	-6	-1/8	-6	-1/8	-6	-6	-6	-6	-1/8	-6
1/8	-	1/4	19	-6	-1/4	-6	-1/4	-6	-1/4	-6	-6	-6	-6	-1/4	-6
1/8	-	3/8	22	-6	-3/8	-6	-3/8	-6	-3/8	-6	-6	-6	-6	-3/8	-6
1/8	-	1/2	27	-6	-1/2	-6	-1/2	-6	-1/2	-6	-6	-6	-6	-1/2	-6
1/4	-	1/8	17	-8	-1/8	-8	-1/8	-8	-1/8	-8	-8	-8	-8	-1/8	-8
1/4	-	1/4	19	-8	-1/4	-8	-1/4	-8	-1/4	-8	-8	-8	-8	-1/4	-8
1/4	-	3/8	22	-8	-3/8	-8	-3/8	-8	-3/8	-8	-8	-8	-8	-3/8	-8
1/4	-	1/2	27	-8	-1/2	-8	-1/2	-8	-1/2	-8	-8	-8	-8	-1/2	-8
3/8	-	1/4	22	-10	-1/4	-10	-1/4	-10	-1/4	-10	-10	-10	-10	-1/4	-10
3/8	-	3/8	24	-10	-3/8	-10	-3/8	-10	-3/8	-10	-10	-10	-10	-3/8	-10
3/8	-	1/2	30	-10	-1/2	-10	-1/2	-10	-1/2	-10	-10	-10	-10	-1/2	-10
1/2	-	1/4	27	-12	-1/4	-12	-1/4	-12	-1/4	-12	-12	-12	-12	-1/4	-12
1/2	-	3/8	27	-12	-3/8	-12	-3/8	-12	-3/8	-12	-12	-12	-12	-3/8	-12
1/2	-	1/2	30	-12	-1/2	-12	-1/2	-12	-1/2	-12	-12	-12	-12	-1/2	-12
1/2	-	3/4	32	-12	-3/4	-12	-3/4	-12	-3/4	-12	-12	-12	-12	-3/4	-12
1/2	-	1/4	27	-14	-1/4	-14	-1/4	-14	-1/4	-14	-14	-14	-14	-1/4	-14
1/2	-	3/8	27	-14	-3/8	-14	-3/8	-14	-3/8	-14	-14	-14	-14	-3/8	-14
1/2	-	1/2	30	-14	-1/2	-14	-1/2	-14	-1/2	-14	-14	-14	-14	-1/2	-14
1/2	-	3/4	32	-14	-3/4	-14	-3/4	-14	-3/4	-14	-14	-14	-14	-3/4	-14
1/2	-	1/4	27	-15	-1/4	-15	-1/4	-15	-1/4	-15	-15	-15	-15	-1/4	-15
1/2	-	3/8	27	-15	-3/8	-15	-3/8	-15	-3/8	-15	-15	-15	-15	-3/8	-15
1/2	-	1/2	30	-15	-1/2	-15	-1/2	-15	-1/2	-15	-15	-15	-15	-1/2	-15
1/2	-	3/4	32	-15	-3/4	-15	-3/4	-15	-3/4	-15	-15	-15	-15	-3/4	-15

Die Übergangsmuffe SO 00030 kann an jedes SERTO-Formteil anstelle des Armaturenanschlusses SO 00021 mit dem passenden zylindrischen Gewinde G aufgeschraubt werden.

In Verbindung mit den Formteilen ist die Übergangsmuffe SO 00030 nur lose aufgeschraubt und muss bei der Montage angezogen werden.

Dichtungsprinzip siehe SO 00030.

L'adaptateur femelle SO 00030 peut être monté sur toutes les pièces de forme SERTO avec le filetage cylindrique G correspondant, au lieu et place de l'écrou SO 00021.

En cas de livraison avec des pièces SERTO, l'adaptateur SO 00030 n'est que très légèrement vissé et doit être resserré lors du montage.

Principe de l'étanchéité et filetage voir SO 00030.

The female adaptor SO 00030 can be fitted to any SERTO forged body in place of the nut connection SO 00021 with the relevant straight thread G.

Combinations are supplied with the female adaptor SO 00030 screwed only loosely on the body. It must be tightened for installation.

See SO 00030 for sealing principle.

Anschlussvarianten mit Übergangsmuffe

Variantes de raccordement avec adaptateur femelle

Connections with female adaptor

SO 00030

SO 02221

SO 03221

SO 04221

SO 05221

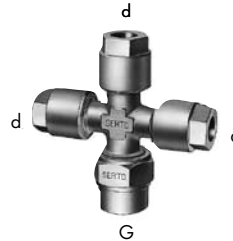
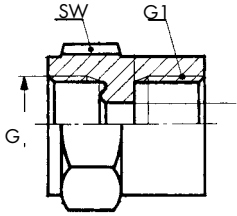

G	-	G1	SW	-d	-G	-d	-G	-d	-G	-d	-d	-d	-G	-d
1/8	-	1/8 NPT	14	-4	-1/8 NPT	-4	-1/8 NPT	-4	-1/8 NPT	-4	-4	-4	-1/8 NPT	-4
1/8	-	1/4 NPT	19	-4	-1/4 NPT	-4	-1/4 NPT	-4	-1/4 NPT	-4	-4	-4	-1/4 NPT	-4
1/8	-	1/8 NPT	14	-5	-1/8 NPT	-5	-1/8 NPT	-5	-1/8 NPT	-5	-5	-5	-1/8 NPT	-5
1/8	-	1/4 NPT	19	-5	-1/4 NPT	-5	-1/4 NPT	-5	-1/4 NPT	-5	-5	-5	-1/4 NPT	-5
1/8	-	1/8 NPT	14	-6	-1/8 NPT	-6	-1/8 NPT	-6	-1/8 NPT	-6	-6	-6	-1/8 NPT	-6
1/8	-	1/4 NPT	19	-6	-1/4 NPT	-6	-1/4 NPT	-6	-1/4 NPT	-6	-6	-6	-1/4 NPT	-6
1/4	-	1/8 NPT	17	-8	-1/8 NPT	-8	-1/8 NPT	-8	-1/8 NPT	-8	-8	-8	-1/8 NPT	-8
1/4	-	1/4 NPT	19	-8	-1/4 NPT	-8	-1/4 NPT	-8	-1/4 NPT	-8	-8	-8	-1/4 NPT	-8
3/8	-	1/4 NPT	22	-10	-1/4 NPT	-10	-1/4 NPT	-10	-1/4 NPT	-10	-10	-10	-1/4 NPT	-10
3/8	-	3/8 NPT	22	-10	-3/8 NPT	-10	-3/8 NPT	-10	-3/8 NPT	-10	-10	-10	-3/8 NPT	-10
1/2	-	3/8 NPT	30	-12	-3/8 NPT	-12	-3/8 NPT	-12	-3/8 NPT	-12	-12	-12	-3/8 NPT	-12
1/2	-	1/2 NPT	30	-12	-1/2 NPT	-12	-1/2 NPT	-12	-1/2 NPT	-12	-12	-12	-1/2 NPT	-12
1/2	-	3/8 NPT	30	-14	-3/8 NPT	-14	-3/8 NPT	-14	-3/8 NPT	-14	-14	-14	-3/8 NPT	-14
1/2	-	1/2 NPT	30	-14	-1/2 NPT	-14	-1/2 NPT	-14	-1/2 NPT	-14	-14	-14	-1/2 NPT	-14
1/2	-	3/8 NPT	30	-15	-3/8 NPT	-15	-3/8 NPT	-15	-3/8 NPT	-15	-15	-15	-3/8 NPT	-15
1/2	-	1/2 NPT	30	-15	-1/2 NPT	-15	-1/2 NPT	-15	-1/2 NPT	-15	-15	-15	-1/2 NPT	-15

Die Übergangsmuffe SO 00030 kann an jedes SERTO-Formteil anstelle des Armaturenanschlusses SO 00021 mit dem passenden zylindrischen Gewinde G aufgeschraubt werden.

In Verbindung mit den Formteilen ist die Übergangsmuffe SO 00030 nur lose aufgeschraubt und muss bei der Montage angezogen werden.

Dichtungsprinzip siehe SO 00030.

L'adaptateur femelle SO 00030 peut être monté sur toutes les pièces de forme SERTO avec le filetage cylindrique G correspondant, au lieu et place de l'écrou SO 00021.

En cas de livraison avec des pièces SERTO, l'adaptateur SO 00030 n'est que très légèrement vissé et doit être resserré lors du montage.

Principe de l'étanchéité et filetage voir SO 00030.

The female adaptor SO 00030 can be fitted to any SERTO forged body in place of the nut connection SO 00021 with the relevant straight thread G.

Combinations are supplied with the female adaptor SO 00030 screwed only loosely on the body. It must be tightened for installation.

See SO 00030 for sealing principle.

4G

Anschlussvarianten mit Übergangsnippel

Variantes de raccordement avec adaptateur mâle

Connections with male adaptor

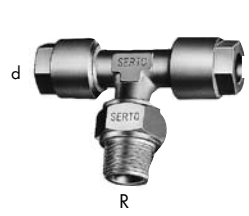
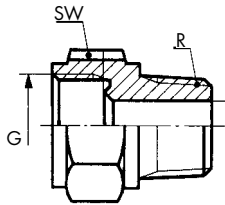
SO 00040
SO 02121
SO 03121
SO 04121
SO 05121

G	-	G1	SW	-d	-R	-d	-R	-d	-d	-R	-d	-d	-d	-G	-d
1/8	-	1/8	14								-4	-1/8	-4	-4	-4
1/8	-	1/4	14	-4	-1/4	-4	-1/4	-4	-4	-1/4	-4	-4	-4	-4	-4
1/8	-	3/8	17	-4	-3/8	-4	-3/8	-4	-4	-3/8	-4	-4	-4	-4	-4
1/8	-	1/2	22	-4	-1/2	-4	-1/2	-4	-4	-1/2	-4	-4	-4	-4	-4
1/8	-	1/8	14								-5	-1/8	-5	-5	-5
1/8	-	1/4	14	-5	-1/4	-5	-1/4	-5	-5	-1/4	-5	-5	-5	-5	-5
1/8	-	3/8	17	-5	-3/8	-5	-3/8	-5	-5	-3/8	-5	-5	-5	-5	-5
1/8	-	1/2	22	-5	-1/2	-5	-1/2	-5	-5	-1/2	-5	-5	-5	-5	-5
1/8	-	1/8	14								-6	-1/8	-6	-6	-6
1/8	-	1/4	14								-6	-1/4	-6	-6	-6
1/8	-	3/8	17	-6	-3/8	-6	-3/8	-6	-6	-3/8	-6	-6	-6	-6	-6
1/8	-	1/2	22	-6	-1/2	-6	-1/2	-6	-6	-1/2	-6	-6	-6	-6	-6
1/4	-	1/8	17					-8	-1/8	-8	-8	-1/8	-8	-8	-8
1/4	-	1/4	17								-8	-1/4	-8	-8	-8
1/8	-	3/8	17					-8	-3/8	-8	-8	-3/8	-8	-8	-8
1/4	-	1/2	22	-8	-1/2	-8	-1/2	-8	-8	-1/2	-8	-8	-8	-8	-8
3/8	-	1/4	22								-10	-1/4	-10	-10	-10
3/8	-	3/8	22								-10	-3/8	-10	-10	-10
3/8	-	1/2	22					-10	-1/2	-10	-10	-1/2	-10	-10	-10
1/2	-	1/4	27					-12	-1/4	-12	-12	-1/4	-12	-12	-12
1/2	-	3/8	27					-12	-3/8	-12	-12	-3/8	-12	-12	-12
1/2	-	1/2	27					-12	-1/2	-12	-12	-1/2	-12	-12	-12
1/2	-	3/4	30	-12	-3/4	-12	-3/4	-12	-12	-3/4	-12	-12	-12	-12	-12
1/2	-	1/4	27	-14	-1/4	-14	-1/4	-14	-14	-1/4	-14	-14	-14	-14	-14
1/2	-	3/8	27					-14	-3/8	-14	-14	-3/8	-14	-14	-14
1/2	-	1/2	27					-14	-1/2	-14	-14	-1/2	-14	-14	-14
1/2	-	3/4	30					-14	-3/4	-14	-14	-3/4	-14	-14	-14
1/2	-	1/4	27	-15	-1/4	-15	-1/4	-15	-15	-1/4	-15	-15	-15	-15	-15
1/2	-	3/8	27					-15	-3/8	-15	-15	-3/8	-15	-15	-15
1/2	-	1/2	27					-15	-1/2	-15	-15	-1/2	-15	-15	-15
1/2	-	3/4	30					-15	-3/4	-15	-15	-3/4	-15	-15	-15

Der Übergangsnippel SO 00040 kann an jedes SERTO-Formteil anstelle des Armaturenan schlusses SO 00021 mit dem passenden zylindrischen Gewinde G aufgeschraubt werden.

In Verbindung mit dem Formteil ist der Übergangsnippel SO 00040 nur lose aufgeschraubt und muss bei der Montage angezogen werden.

Dichtungsprinzip siehe SO 00040.

L'adaptateur mâle SO 00040 peut être monté sur toutes les pièces de forme SERTO avec le filetage cylindrique G correspondant, au lieu et place de l'écrou SO 00021.

En cas de livraison avec des pièces SERTO, l'adaptateur SO 00040 n'est que très légèrement vissé et doit être resserré lors du montage.

Principe de l'étanchéité et filetage voir SO 00040.

The male adaptor SO 00040 can be fitted to any SERTO forged body in place of the nut connection SO 00021 with the relevant straight thread G.

Combinations are supplied with the male adaptor SO 00040 screwed only loosely on the body. It must be tightened for installation.

See SO 00040 for sealing principle.

Anschlussvarianten mit Übergangsnippel

Variantes de raccordement avec adaptateur mâle

Connections with male adaptor

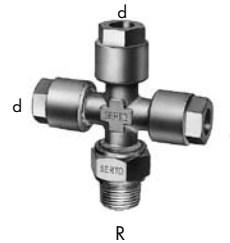
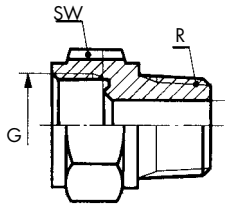
SO 00040
SO 02121
SO 03121
SO 04121
SO 05121

G	-	G1	SW	-d	-R	-d	-R	-d	-d	-R	-d	-d	-d	-G	-d
1/8	-	1/8 NPT	14			-4	-1/8 NPT	-4	-4	-1/8 NPT	-4	-4	-4	-1/8 NPT	-4
1/8	-	1/4 NPT	14	-4	-1/4 NPT	-4	-1/4 NPT	-4	-4	-1/4 NPT	-4	-4	-4	-1/4 NPT	-4
1/8	-	1/8 NPT	14			-5	-1/8 NPT	-5	-5	-1/8 NPT	-5	-5	-5	-1/8 NPT	-5
1/8	-	1/4 NPT	14	-5	-1/4 NPT	-5	-1/4 NPT	-5	-5	-1/4 NPT	-5	-5	-5	-1/4 NPT	-5
1/8	-	1/8 NPT	14			-6	-1/8 NPT	-6	-6	-1/8 NPT	-6	-6	-6	-1/8 NPT	-6
1/8	-	1/4 NPT	14			-6	-1/4 NPT	-6	-6	-1/4 NPT	-6	-6	-6	-1/4 NPT	-6
1/4	-	1/8 NPT	17			-8	-1/8 NPT	-8	-8	-1/8 NPT	-8	-8	-8	-1/8 NPT	-8
1/4	-	1/4 NPT	17			-8	-1/4 NPT	-8	-8	-1/4 NPT	-8	-8	-8	-1/4 NPT	-8
1/4	-	3/8 NPT	17	-8	-3/8 NPT	-8	-3/8 NPT	-8	-8	-3/8 NPT	-8	-8	-8	-3/8 NPT	-8
3/8	-	1/4 NPT	22			-10	-1/4 NPT	-10	-10	-1/4 NPT	-10	-10	-10	-1/4 NPT	-10
3/8	-	3/8 NPT	22			-10	-3/8 NPT	-10	-10	-3/8 NPT	-10	-10	-10	-3/8 NPT	-10
1/2	-	3/8 NPT	27			-12	-3/8 NPT	-12	-12	-3/8 NPT	-12	-12	-12	-3/8 NPT	-12
1/2	-	1/2 NPT	27			-12	-1/2 NPT	-12	-12	-1/2 NPT	-12	-12	-12	-1/2 NPT	-12
1/2	-	3/8 NPT	27			-14	-3/8 NPT	-14	-14	-3/8 NPT	-14	-14	-14	-3/8 NPT	-14
1/2	-	1/2 NPT	27			-14	-1/2 NPT	-14	-14	-1/2 NPT	-14	-14	-14	-1/2 NPT	-14
1/2	-	3/8 NPT	27			-15	-3/8 NPT	-15	-15	-3/8 NPT	-15	-15	-15	-3/8 NPT	-15
1/2	-	1/2 NPT	27			-15	-1/2 NPT	-15	-15	-1/2 NPT	-15	-15	-15	-1/2 NPT	-15

	SW	-d	-R	-d	-R	-d	-d	-R	-d	-d	-d	-G	-d
1/8-M10x1	14	-4	-M10x1	-4	-M10x1	-4	-4	-M10x1	-4	-4	-4	-M10x1	-4
1/8-M10x1	14	-5	-M10x1	-5	-M10x1	-5	-5	-M10x1	-5	-5	-5	-M10x1	-5
1/8-M10x1	14	-6	-M10x1	-6	-M10x1	-6	-6	-M10x1	-6	-6	-6	-M10x1	-6
1/4-M12x1,5	17	-8	-M12x1,5	-8	-M12x1,5	-8	-8	-M12x1,5	-8	-8	-8	-M12x1,5	-8
3/8-M14x1,5	22	-10	-M14x1,5	-10	-M14x1,5	-10	-10	-M14x1,5	-10	-10	-10	-M14x1,5	-10
1/2-M16x1,5	27	-12	-M16x1,5	-12	-M16x1,5	-12	-12	-M16x1,5	-12	-12	-12	-M16x1,5	-12
1/2-M16x1,5	27	-14	-M16x1,5	-14	-M16x1,5	-14	-14	-M16x1,5	-14	-14	-14	-M16x1,5	-14
1/2-M16x1,5	27	-15	-M16x1,5	-15	-M16x1,5	-15	-15	-M16x1,5	-15	-15	-15	-M16x1,5	-15

Der Übergangsnippel SO 00040 kann an jedes SERTO-Formteil anstelle des Armaturenan schlusses SO 00021 mit dem passenden zylindrischen Gewinde G aufgeschraubt werden.

In Verbindung mit dem Formteil ist der Übergangsnippel SO 00040 nur lose aufgeschraubt und muss bei der Montage angezogen werden.

Dichtungsprinzip siehe SO 00040.

L'adaptateur mâle SO 00040 peut être monté sur toutes les pièces de forme SERTO avec le filetage cylindrique G correspondant, au lieu et place de l'écrou SO 00021.

En cas de livraison avec des pièces SERTO, l'adaptateur SO 00040 n'est que très légèrement vissé et doit être resserré lors du montage.

Principe de l'étanchéité et filetage voir SO 00040.

The male adaptor SO 00040 can be fitted to any SERTO forged body in place of the nut connection SO 00021 with the relevant straight thread G.

Combinations are supplied with the male adaptor SO 00040 screwed only loosely on the body. It must be tightened for installation.

See SO 00040 for sealing principle.

4G

Doppelnippel zylindrisch Adaptateur mâle cylindrique Male adaptor parallel

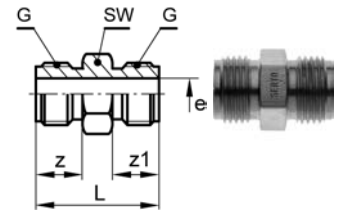

SO 01020

Type -G	Mat.-Nr.	bar	SW	L	z1	e	kg/100
SO 01020-1/8-1/8	246.1020.060	125	12	26.0	10.0	4.5	1.420
SO 01020-1/4-1/4	246.1020.080	125	14	28.0	11.0	6.5	2.150
SO 01020-3/8-3/8	246.1020.100	100	17	30.0	11.5	8.5	3.800
SO 01020-1/2-1/2	246.1020.140	64	22	36.0	14.0	12.0	6.450

Doppelnippel zylindrisch reduziert Adaptateur mâle cylindrique réduit Male adaptor parallel reduced

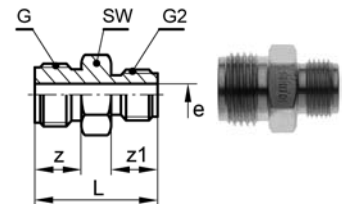

SO 01020 RED

Type -G -G2	Mat.-Nr.	bar	SW	L	z1	z	e	kg/100
SO 01020-1/4-1/8	246.1024.140	125	14	27.0	10.0	11.0	4.5	2.100
SO 01020-3/8-1/4	246.1024.190	100	17	29.5	11.0	11.5	6.5	3.450
SO 01020-1/2-3/8	246.1024.240	64	22	33.5	11.5	14.0	8.5	6.200

Doppelnippel zylindrisch/kegelig Nipple mâle cylindrique/conique Male adaptor nipple parallel/tapered

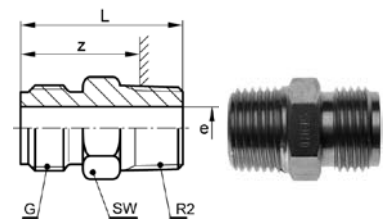

SO 01100

Type -G -R2	Mat.-Nr.	bar	SW	L	z	e	kg/100
G=Rohrgewinde (zylindrisch)	G=Filetage-gaz BSP (cylindrique)	G=BSP thread (straight)					
R2=Rohrgewinde (kegelig)	R2=Filetage-gaz BSP (conique)	R2=BSP thread (tapered)					
SO 01100-1/8 Z-1/8 K	246.1101.100	125	10	22.0	18.0	4.0	1.310
SO 01100-1/8 Z-1/4 K	246.1101.110	125	14	28.0	22.0	4.0	2.010
SO 01100-1/8 Z-3/8 K	246.1101.120	125	17	28.0	21.6	4.0	2.810
SO 01100-1/4 Z-1/8 K	246.1101.160	125	14	25.0	21.0	5.0	2.010
SO 01100-1/4 Z-1/4 K	246.1101.170	125	14	29.0	23.0	6.5	2.410
SO 01100-1/4 Z-3/8 K	246.1101.180	125	17	29.0	22.6	6.5	3.210
SO 01100-1/4 Z-1/2 K	246.1101.185	125	22	34.0	25.8	6.5	4.910
SO 01100-3/8 Z-1/4 K	246.1101.270	100	17	29.5	23.5	8.5	2.970
SO 01100-3/8 Z-3/8 K	246.1101.280	100	17	29.5	23.1	8.5	3.570
SO 01100-3/8 Z-1/2 K	246.1101.285	100	22	34.5	26.3	8.5	5.270
SO 01100-1/2 Z-1/4 K	246.1101.380	64	22	33.0	27.0	8.0	5.970
SO 01100-1/2 Z-3/8 K	246.1101.390	64	22	33.0	26.6	10.0	5.770
SO 01100-1/2 Z-1/2 K	246.1101.504	64	22	37.0	28.8	12.0	6.260
SO 01100-1/2 Z-3/4 K	246.1101.506	64	27	39.0	29.5	12.0	8.860
SO 01100-3/4 Z - 1/2 K	246.1101.596	64	27	40.0	31.8	14.0	9.190
SO 01100-3/4 Z-3/4 K	246.1101.598	64	27	40.0	30.5	15.0	10.190

Doppelnippel zylindrisch

mit Dichtkante

Nipple mâle cylindrique

avec arête d'étanchéité

Male adaptor nipple parallel

with sealing lip

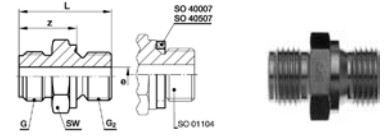

SO 01104

Type -G -G2	Mat.-Nr.	bar	SW	L	z	e	kg/100
SO 01104-1/8-1/8	246.1141.100	125	14	23.5	15.5	4.0	1.410
SO 01104-1/8-1/4	246.1141.110	125	19	29.0	17.0	4.0	3.010
SO 01104-1/4-1/8	246.1141.160	125	14	24.5	16.5	5.0	1.710
SO 01104-1/4-1/4	246.1141.170	125	19	30.0	18.0	6.0	3.110
SO 01104-1/4-3/8	246.1141.180	125	22	31.5	19.5	6.0	4.010
SO 01104-3/8-1/4	246.1141.270	100	19	30.5	18.5	8.5	3.570
SO 01104-3/8-3/8	246.1141.280	100	22	32.0	20.0	8.5	5.470
SO 01104-1/2-1/4	246.1141.380	64	22	34.5	22.5	7.0	6.600
SO 01104-1/2-3/8	246.1141.390	64	22	34.5	22.5	9.0	6.270
SO 01104-1/2-1/2	246.1141.504	64	27	38.0	24.0	12.0	9.490

Anschlussmuffe zylindrisch

(Aussen-/Innengewinde)

Adaptateur femelle cylindrique

(filetage mâle/femelle)

Female adaptor

(male/female thread)

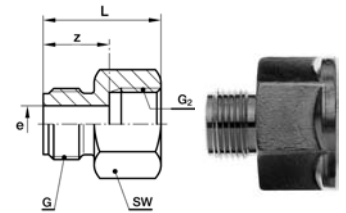

SO 01200

Type -G -G2	Mat.-Nr.	bar	SW	L	z	e	kg/100
SO 01200-1/8a-1/8i	246.1201.100	125	14	23.0	13.0	4.0	1.610
SO 01200-1/8a-1/4i	246.1201.110	125	17	24.5	13.5	4.0	2.310
SO 01200-1/8a-3/8i	246.1201.120	125	22	26.0	14.0	4.0	4.010
SO 01200-1/4a-1/8i	246.1201.160	125	14	24.0	14.0	6.0	2.010
SO 01200-1/4a-1/4i	246.1201.170	125	17	25.5	14.5	6.0	2.610
SO 01200-1/4a-3/8i	246.1201.180	125	22	27.0	15.0	6.4	4.010
SO 01200-1/4a-1/2i	246.1201.185	125	27	29.5	15.5	6.4	6.710
SO 01200-3/8a-1/4i	246.1201.270	100	17	26.0	15.0	8.4	2.970
SO 01200-3/8a-3/8i	246.1201.280	100	22	27.0	15.0	8.5	4.370
SO 01200-3/8a-1/2i	246.1201.285	100	27	30.0	16.0	8.5	6.970
SO 01200-3/8a-3/4i	246.1201.290	100	32	33.0	16.0	8.5	9.970
SO 01200-1/2a-3/8i	246.1201.390	64	22	30.0	18.0	10.2	5.370
SO 01200-1/2a-1/2i	246.1201.504	64	27	32.5	18.5	12.5	7.860
SO 01200-1/2a-3/4i	246.1201.506	64	32	35.5	18.5	12.5	11.060
SO 01200-3/4a-1/2i	246.1201.596	64	27	35.5	19.5	14.5	11.060
SO 01200-3/4a-3/4i	246.1201.598	64	32	36.5	19.5	15.5	11.060

Schott-Doppelnippel zylindrisch
Adaptateur mâle cylindrique pour cloison
Panel male adaptor parallel

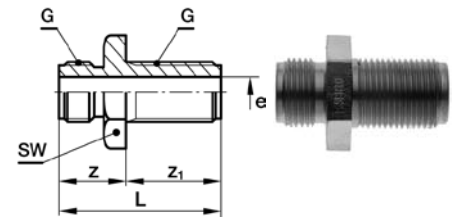

SO 01500

Type -G	Mat.-Nr.	bar	SW	L	z1	z	e	kg/100
SO 01500-1/8	246.1500.060	125	14	35.0	20.0	15.0	4.0	1.900
SO 01500-1/4	246.1500.080	125	19	38.0	22.0	16.0	6.5	3.400
SO 01500-3/8	246.1500.100	100	24	40.0	22.5	17.5	8.5	6.100
SO 01500-1/2	246.1500.120	100	30	47.0	26.0	21.0	12.0	11.900

Schott-Doppelnippel zylindrisch
Adaptateur mâle cylindrique pour cloison
Panel male adaptor parallel

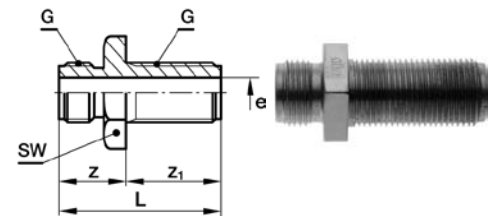

SO 01504

Type -G	Mat.-Nr.	bar	SW	L	z1	z	e	kg/100
SO 01504-1/2	246.1540.140	100	30	58.0	37.0	21.0	12.0	11.800

Winkel zylindrisch
Coude cylindrique
Elbow union parallel

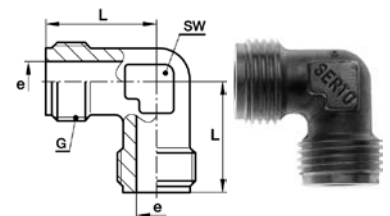

SO 02000

Type -G	Mat.-Nr.	bar	SW	L	e	kg/100
SO 02000-1/8	246.2000.060	125	10	19.0	4.0	1.620
SO 02000-1/4	246.2000.080	125	11	21.0	6.0	2.520
SO 02000-3/8	246.2000.100	100	14	22.0	8.0	3.740
SO 02000-1/2	246.2000.140	64	17	25.0	12.0	6.640
SO 02000-3/4	246.2000.170	64	22	30.0	15.0	11.580

Winkel zylindrisch/kegelig
Coude cylindrique/conique
Elbow union parallel/tapered

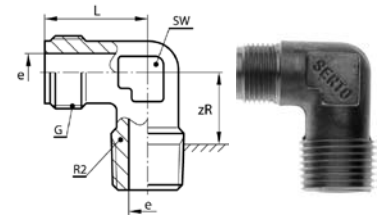
SO 02400

Type -G-R2	Mat.-Nr.	bar	SW	L	zR	e	kg/100
G=Rohrgewinde (zylindrisch)	G=Filetage-gaz BSP (cylindrique)				G=BSP thread (straight)		
R2=Rohrgewinde (kegelig)	R2=Filetage-gaz BSP (conique)				R2=BSP thread (tapered)		
SO 02400-1/8 Z-1/8 K	246.2401.100	125	10	20.0	13.5	4.0	1.700
SO 02400-1/8 Z-1/4 K	246.2401.110	125	11	21.0	15.0	4.0	2.600
SO 02400-1/4 Z-1/8 K	246.2401.160	125	11	21.0	14.5	5.0	2.300
SO 02400-1/4 Z-1/4 K	246.2401.170	125	11	21.0	15.0	6.0	2.800
SO 02400-1/4 Z-3/8 K	246.2401.180	125	14	22.0	16.0	6.0	4.200
SO 02400-3/8 Z-1/4 K	246.2401.270	100	14	22.0	15.0	7.0	3.700
SO 02400-3/8 Z-3/8 K	246.2401.280	100	14	22.0	16.0	8.0	4.300
SO 02400-3/8 Z-1/2 K	246.2401.285	100	19	28.0	19.0	8.0	6.700
SO 02400-1/2 Z-1/4 K	246.2401.380	64	17	25.0	16.0	7.0	5.900
SO 02400-1/2 Z-3/8 K	246.2401.390	64	17	25.0	16.0	10.0	5.900
SO 02400-1/2 Z-1/2 K	246.2401.504	64	19	28.0	19.0	12.0	7.900
SO 02400-1/2 Z-3/4 K	246.2401.506	64	22	30.0	20.0	12.0	8.300
SO 02400-3/4 Z-1/2 K	246.2401.596	64	22	30.0	20.0	14.0	10.600
SO 02400-3/4 Z-3/4 K	246.2401.598	64	22	30.0	20.0	15.0	12.700

T-Stück zylindrisch
Pièce Té cylindrique
Tee parallel

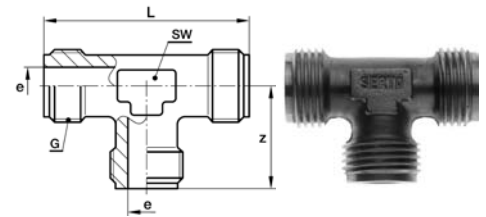
SO 03000

Type -G	Mat.-Nr.	bar	SW	L	z	e	kg/100
SO 03000-1/8	246.3000.060	125	10	38.0	19.0	4.0	2.200
SO 03000-1/4	246.3000.080	125	11	42.0	21.0	6.0	3.600
SO 03000-3/8	246.3000.100	100	14	44.0	22.0	8.0	5.200
SO 03000-1/2	246.3000.120	100	17	50.0	25.0	11.0	9.300
SO 03000-3/4	246.3000.170	64	27	64.0	32.0	15.0	15.700

